

XRS-3 X-RAY SOURCE



OPERATOR'S MANUAL

CONTENTS

ITEM	PAGE
1.0 INTRODUCTION.....	2
2.0 WARNINGS.....	2
EXCLUSION ZONE DIAGRAM.....	4
3.0 PHYSICAL DESCRIPTION.....	5
3.1 HIGH VOLTAGE PULSER/TUBEHEAD.....	5
3.2 BASE.....	5
3.3 CONTROL MODULE.....	6
3.4 BATTERY PACK.....	7
3.5 BATTERY CHARGER.....	7
CABLE CONNECTOR DIAGRAM.....	8
4.0 DESCRIPTION OF OPERATION.....	9
BLOCK DIAGRAM.....	10
5.0 OPERATING INSTRUCTIONS.....	11
5.1 OPERATING PRECAUTIONS.....	11
5.2 OPERATING PROCEDURES.....	11
5.3 REMOTE CABLE OPTION.....	11
5.4 DELAY MODE OPTION.....	13
5.5 REAL TIME IMAGING OPTION.....	13
5.6 DEFAULT PULSE SETTING.....	14
5.7 PULSE SETTINGS.....	14
5.8 DUTY CYCLE.....	16
6.0 SOFTWARE.....	16
7.0 MAINTENANCE.....	17
7.1 DOSE MEASUREMENT.....	17
7.2 TUBE REPLACEMENT.....	17
8.0 TROUBLE-SHOOTING.....	18
9.0 INSTRUCTIONS FOR REPAIR.....	18
9.1 HANDLE REPLACEMENT.....	18
9.2 FUSE REPLACEMENT.....	19
9.3 REMOVING BOARDS.....	19
9.4 BOARD INSTALLATION.....	20
9.4 HEAD REPLACEMENT.....	21
9.5 BATTERY DISPOSAL.....	21
10.0 WARRANTY.....	22
11.0 SPECIFICATIONS.....	23
10.1 PHYSICAL DIMENSIONS.....	23
10.2 X-RAY OUTPUT.....	23
10.3 ELECTRICAL & THERMAL CHARACTERISTICS.....	23
10.4 X-RAY LEAKAGE.....	23
12.0 SPARE PARTS.....	24

1.0 INTRODUCTION

The XRS-3 produces high levels of radiation and must be operated by qualified personnel who have read the Warning and Operations section of the manual before operating the device.

The XRS-3 is a small, lightweight x-ray generator that operates on its own removable battery pack. The XRS-3 is a pulsed x-ray device that produces x-ray pulses of very short duration (50 nanoseconds). It produces a relatively low dose rate comparable to a 1.0 ma constant potential machine. The energy produced by the XRS-3 is up to 270KVP, which makes it possible to radiograph up to one (1) inch (2.54 cm) of steel.

XRS-3 standard accessories are two keys, two battery packs, and one battery charger. Remote cable, carrying case, and film developing equipment are also common accessories.

2.0 WARNINGS

2.1 The XRS-3 is an industrial type x-ray generator that produces hazardous radiation when energized.

2.2 It is unlawful to use this equipment to intentionally expose humans or to use it for medical radiography.

2.3 *The XRS-3 is subject to state regulation and registration. Contact your state board of health before operating equipment.*

2.4 The operator of the XRS-3 must be properly trained to safely operate the unit.

2.5 Unauthorized personnel should not have access to the XRS-3.

2.6 Develop and closely follow a safe operating system for using the XRS-3.

The safe operating system must ensure that no one is exposed to radiation above the permissible limits which are 2 mR (0.02 mSv) per hour for a member of the public (refer to section 11.0, Specifications, for information concerning x-ray output).

The safe operating system must ensure the XRS-3 is used within federal and state guidelines.

2.7 All operators and users of the XRS-3 x-ray machine must wear a personal radiation monitoring device, such as a TLD (thermoluminescent dosimeter), film badge, and/or a pocket dosimeter **consistent with the appropriate federal, territorial or provincial standards** (note: an electronic dosimeter will not detect the XRS-3 radiation pulses).

Due to the short pulse width of the XRS-3, survey meters of the Geiger-Mueller and scintillator type do not accurately detect the radiation emitted from the x-ray source.

Survey meters should be of the ionization type and should be used in the integration mode. Survey meters must not be used in the rate mode because the XRS-3 does not produce constant radiation. The XRS-3 produces very high rates of radiation for very short periods of time resulting in either unrealistically high readings or no readings for a survey meter in rate mode.

2.8 The XRS-3 has no explosion proof rating and should not be used in an explosive atmosphere. The Spark Gap is vented to the air and could be a source of ignition.

XRS-3 EXCLUSION ZONE

 State Maximum exposure limits
2 mR per hour (3000 pulses)

 Golden Engineering suggested
standoff distance

 = 3'10" (116 cm) to the side
= 7'6" (230 cm) behind

 = XRS-3 X-ray unit

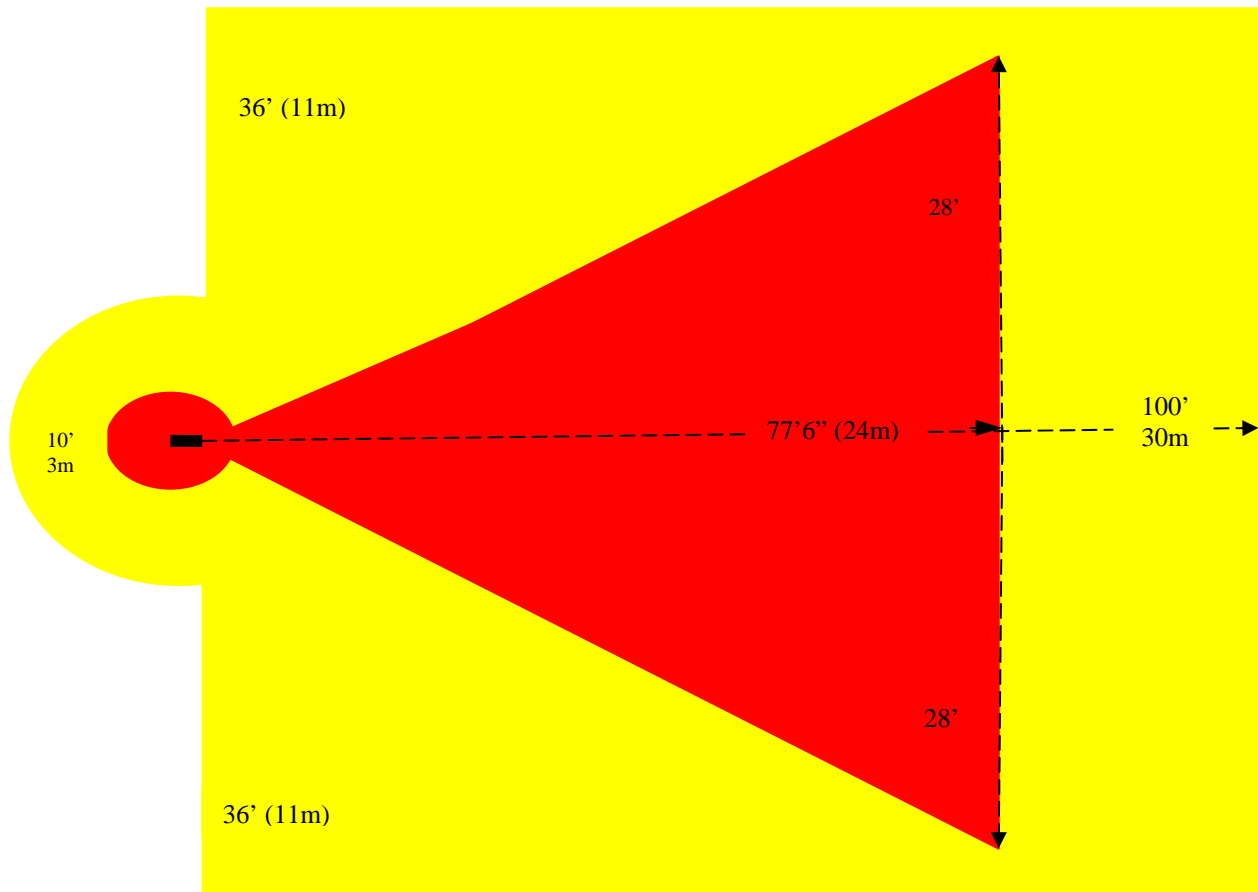

3.0 PHYSICAL DESCRIPTION

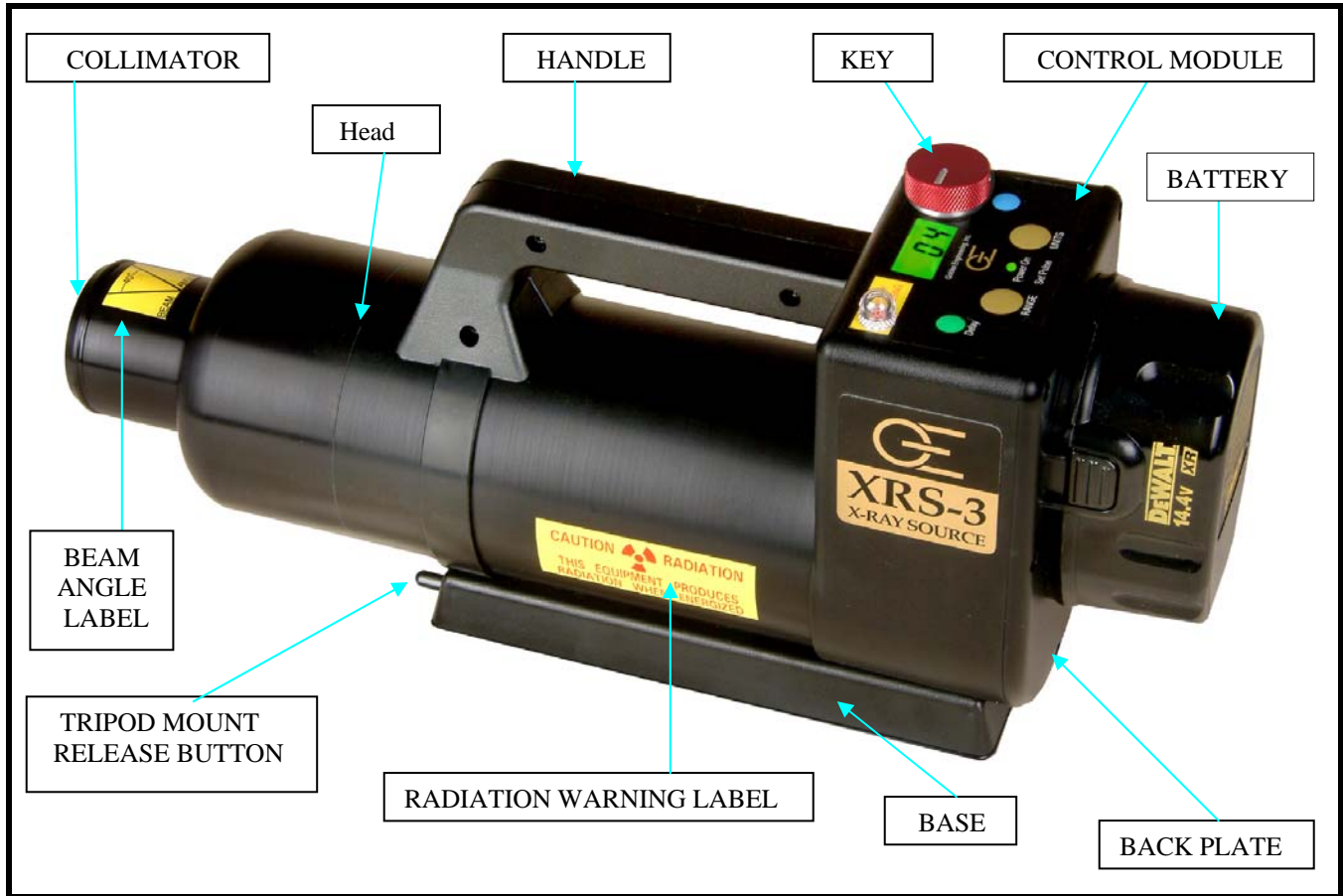

Figure 1: XRS-3 X-ray Unit

3.1 HIGH VOLTAGE PULSER/TUBEHEAD. The main body of the XRS-3 is the tube head which contains the tube cavity, cold cathode type X-ray tube, spark gap, high voltage capacitor, and transformer. The collimator located on the front of the head limits the X-ray beam to 40 degrees.

3.2 BASE. The base of the XRS-3 contains the base plate, tripod mount, tripod mount release button, and identification label. The tripod mount contains threaded ¼-20 insert that can be attached to any standard camera tripod. The release button allows the operator to leave the mount on the tripod head, but remove the XRS-3. A label identifying the model, manufacturer, and serial number is located on the bottom of the XRS-3 base.



Figure 2: Base

3.3 CONTROL MODULE The control module contains the following indicators and switches.

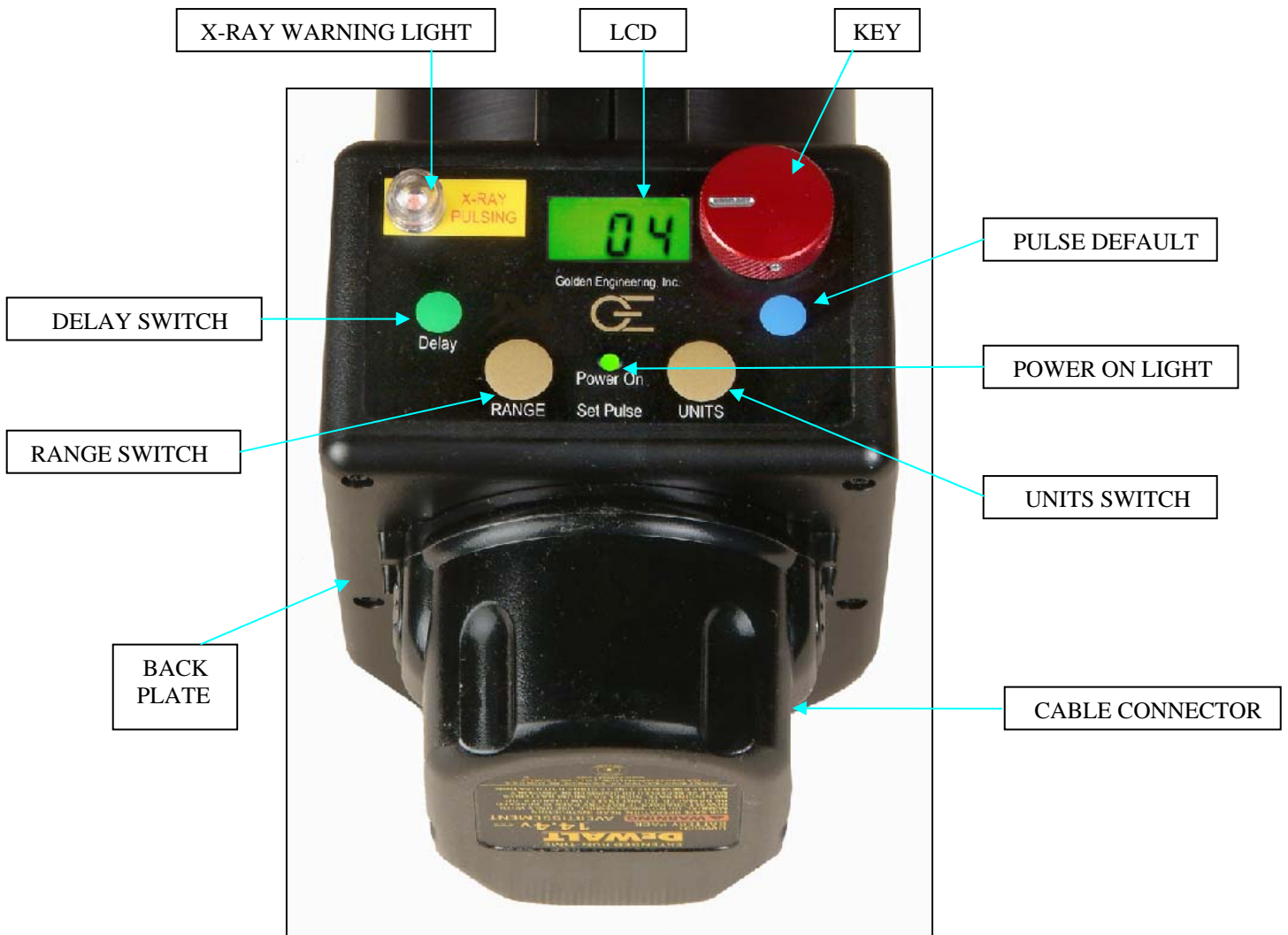

Figure 3: Control Module

- GREEN LED: Power on light. Illuminates when the battery voltage is applied to the control module.
- RED X-RAY WARNING LIGHT: Blinks after the time delay button or remote cable button is pressed to warn that the XRS-3 is going to pulse. The light stays on continuously while the XRS-3 is pulsing.
- LIQUID CRYSTAL DISPLAY (LCD): Displays 2 digits showing the number of counts selected. If the X-ray Warning Light is blinking, then the LCD displays the number of seconds remaining until the XRS-3 begins pulsing. The LCD is backlit so it can be viewed in the dark.

- Input Switches: The two gold push button switches are labeled Range and Units.
 - RANGE SWITCH is used to alternate LCD between tens digit and ones digit when entering pulses.
 - UNITS SWITCH changes the reading of the tens digit or units digit to any number from 0 to 9. The UNITS SWITCH is also used with the blue switch to alter the default pulse setting.
- DELAY SWITCH: This green push button switch is used to initiate delay mode.
- BLUE SWITCH: This switch is pressed with the UNITS SWITCH to alter the default count setting when the XRS-3 is first powered up.
- REMOTE CONNECTOR: This connector located on the back of the control module beneath the battery receives the remote cable or imaging system cable. The diagram on page 8 shows more details about the Remote Connector.
- BACK PLATE: Covers the Oscillator board and contains battery terminal connectors.

3.4 BATTERY PACK. The battery pack is a DeWalt 14.4V nickel-cadmium battery. See enclosed instruction manual from DeWalt for safety and warranty information.

3.5 BATTERY CHARGER: The standard battery charger is the DeWalt DW9116 110V charger or DE9108 220V charger. It takes about one hour to completely charge a battery. See battery charger manual for additional instructions and warnings.

XRS-3 REAR VIEW/CABLE CONNECTOR

PIN #	DESCRIPTION
1	+5 VOLTS 100 ma MAXIMUM
2	REMOTE SWITCH
3	REMOTE SWITCH – NO DELAY
4	X-RAY ON SIGNAL
5	COMMON 0 VOLTS

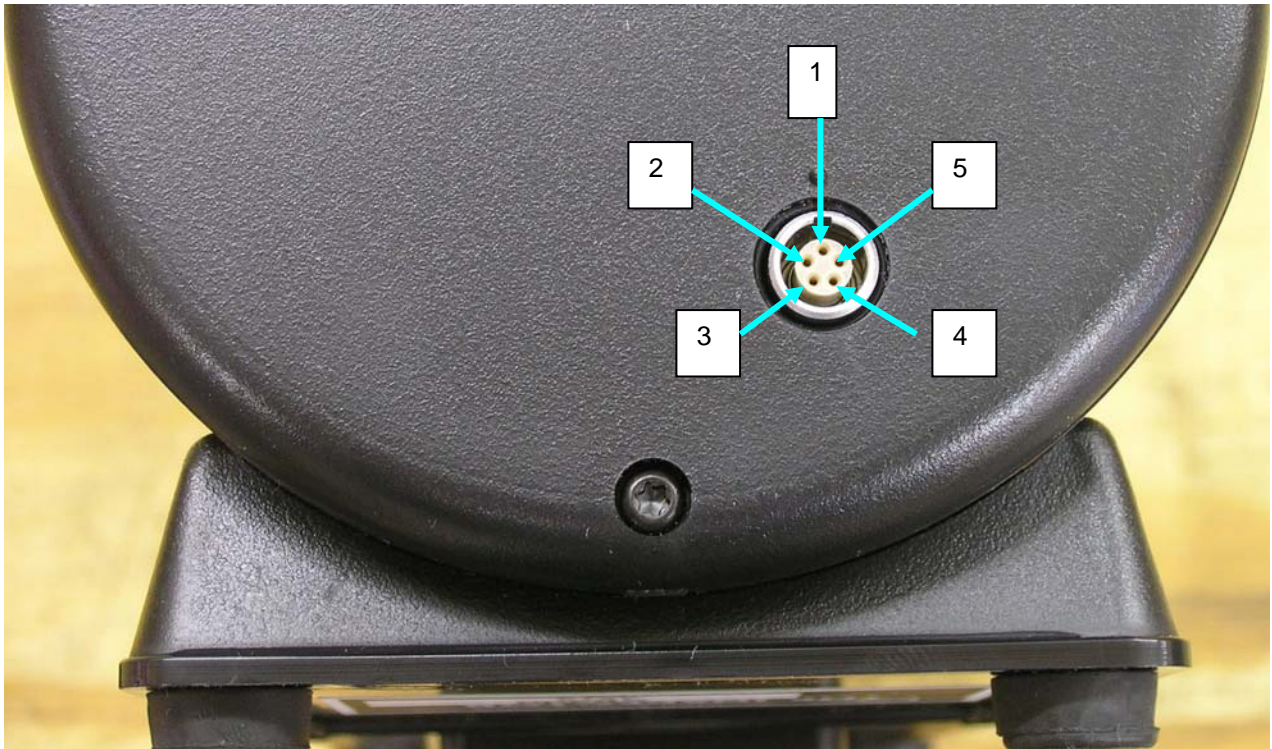

REMOTE CONNECTOR: LEMO EPG.0B.305.HLN
MATING CABLE PLUG: LEMO FGG.0B.305.CLAD 56Z

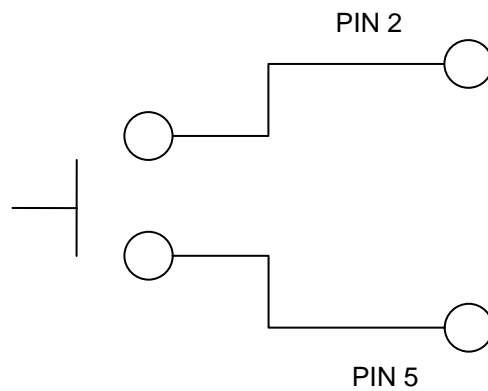

Remote switch inputs are activated when grounded.

4.0 DESCRIPTION OF OPERATION

The block diagram on the page 10 illustrates how the XRS-3 functions. The following sequence of events takes place each time the XRS-3 is fired.

1. User initiates operation of the machine.
2. The control section sends a signal to the converter section to begin oscillating.
3. Once oscillating, the converter section changes the 14.4 volts DC to 22Khz AC.
4. The transformer charges the High Voltage Capacitor to about 8000 volts.
5. The spark gap arcs after the High Voltage Capacitor reaches proper voltage.
6. The pulse detector signals the control block that the unit has pulsed.
7. As the High Voltage Switch is closed, a high voltage transient of about 150,000 volts and 50 nanoseconds in duration is applied across the x-ray tube generating x-rays.

The closing of the High Voltage Switch produces an audible snapping sound. **The XRS-3 cannot produce x-rays without the snapping sound and conversely the snapping sound serves as a warning that the XRS-3 is functioning. The operator should become familiar with the characteristic sound.**

This unit generates x-rays through high voltage bombardment of a tungsten target. ***The XRS-3 does not contain radioactive materials.*** All the high voltage is contained within the aluminum canister and as long as the canister is not punctured the operator is not exposed to dangerous voltages.

XRS-3 BLOCK DIAGRAM

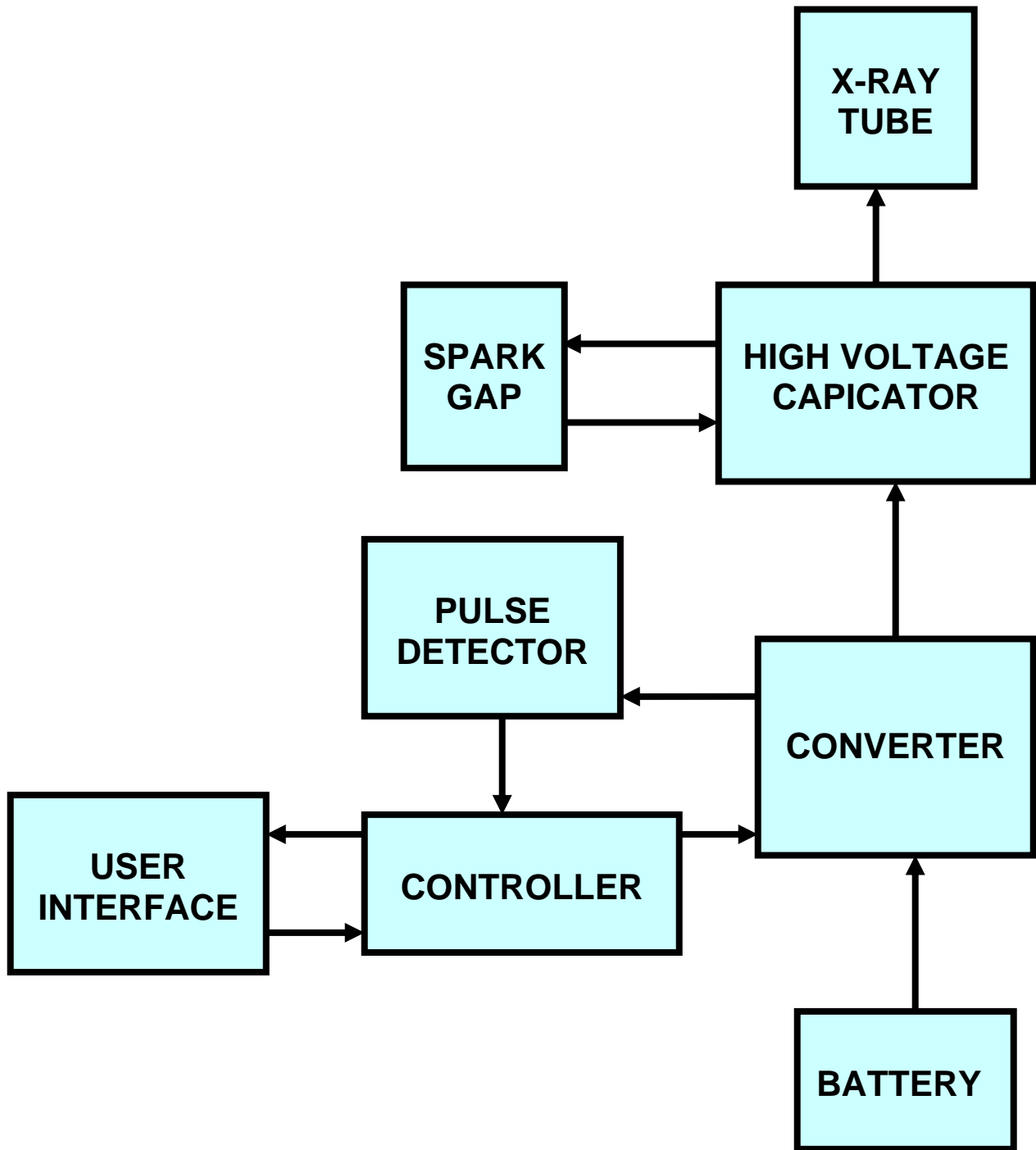

5.0 OPERATING INSTRUCTIONS

5.1 OPERATING PRECAUTIONS: *The operator should always stand at least 10 feet behind the X-ray unit while it is pulsing and clear all personnel at least 100 ft. from the front of the unit. See the Exclusion Zone diagram on page 4 for more details regarding exclusion zone and safe operation distances.*

Closely follow all procedures in the safe operating system.

5.2 OPERATING PROCEDURES: Operating procedures vary depending on the type of imaging system used. The XRS-3 can be used with REMOTE CABLE or TIME DELAY when used with film based systems or Computed Radiography (Phosphor Plate) systems. The XRS-3 should be used in the REAL TIME MODE when used with Direct Radiography systems (CCD, Amorphous Silicon or Amorphous Selenium plates, CMOS Detectors).

5.3 REMOTE CABLE OPTION

1. Attach a fully charged battery pack into the back of the XRS-3.
2. Plug the remote cable into XRS-3.
3. Place the imaging plate or cassette with film negative directly behind the object to be X-rayed. Make sure the cassette or imaging plate is close to the object. Distance between object and cassette will distort the X-ray image.
4. Place the XRS-3 two to four feet in front of the object with the front of the XRS-3 pointing directly at the object.



Figure 4: XRS-3, Cassette & Object

5. Insert key into key switch located on top of the control module. Turn on the XRS-3 by gently turning the key clockwise 1/4 turn.

- In order to select the desired number of pulses for the XRS-3 first depress the RANGE SWITCH. The unit's digit of the LCD will blink twice and then go blank. The UNITS SWITCH can then be used to adjust the unit's digit of the LCD to the desired value.



Step 1



Step 2

- Press the RANGE SWITCH again and the tens digit of the LCD will blink twice and go blank. The UNITS SWITCH can be used to adjust the tens digit to the desired value.



Step 3



Step 4

- Press the RANGE or UNITS SWITCH again for unit to accept the new pulse setting. Both tens digit and units digit will blink to indicate acceptance of the new pulse setting. Alternatively, the unit will accept the new pulse setting after six seconds if RANGE or UNITS button is not pressed again.
- Retreat behind the XRS-3 the length of the cable.
- Fire the XRS-3 by depressing the button on the remote cable.
 - The XRS-3 **delays 5 seconds** before it begins pulsing.
 - The X-ray Warning Light blinks and the LCD displays the number of seconds that remain before the XRS-3 starts pulsing. **The operator may stop the pulsing at any time by releasing the button the remote cable. The LCD will display the number of pulses that remain on the original pulse setting.**
 - The XRS-3 will stop pulsing after it has completed the selected number of pulses.
- Check the XRS-3 to see that original pulse count is on the LCD.
- Turn off key switch.

5.4 DELAY MODE OPTION

Follow the same steps as the remote cable option with the following changes.

1. Do not attach remote cable.
2. After the pulses have been selected and the Exclusion Zone has been cleared of all personnel press the time delay button and retreat at least 10 feet (3m) behind the unit. *The timer starts at 60 seconds. If you hold the delay button down for 1.5 seconds the time delay will change to 15 seconds.*
 - The red warning light starts to blink and the unit makes a beeping sound as soon as the time delay button is pressed.
 - The time delay sequence can be canceled by pressing the RANGE BETTON, UNITS BUTTON, or by turning the unit off.
 - When the time delay counts down to 00 the red light stays on continuously and the XRS-3 begins pulsing.

5.5 REAL TIME IMAGING OPTION

This option is for the PC based Direct Radiography systems that have a control interface between the imaging system and X-ray unit. The interface may be a connector cable from the imager to X-ray unit or it may be a wireless interface.

Follow the same steps as remote cable operation with the following changes.

1. Plug the imager cable into the XRS-3 rather than the remote cable. This step is not necessary if using wireless option.
2. Set the pulses to 99.
3. Change the pulse default setting to 99 if it is not already 99. See section 5.6 for instructions to change the default pulse setting.
4. Place the imager behind the object to be X-rayed and X-ray unit in front of object to be X-rayed.
5. Refer to your imaging system operating instructions for specific details on setting pulses and firing the unit.
6. There is no built in delay when used in this mode. The X-ray will fire immediately unless there is a time delay in the imaging system.

5.6 DEFAULT PULSE SETTING

The default pulse setting displayed on the LCD can be altered by the user through the following steps.



Step 1

Step 2

Step 3

Step 4



Step 5

1. Set the desired pulse setting as described previously and shown in steps one through four above. The digits in the LCD will blink after pulses have been set and registered.
2. Depress the UNITS SWITCH followed by the BLUE SWITCH as shown in step five above. Hold both switches down for 1.5 seconds.
3. Both digits of the LCD will blink indicating that the DEFAULT PULSE SETTING has been changed.
4. Verify the new DEFAULT PULSE SETTING by turning the power to the XRS-3 off and on while observing the LCD. The new setting should appear when the unit powers on.

5.7 SUGGESTED PULSE SETTINGS

The charts on page 15 list approximate pulses necessary to penetrate various materials and the number of pulses necessary to penetrate steel. Settings are based on use with Polaroid 803 film in a cassette with a Calcium Tungstate L-plus screen. Distance between the front of the XRS-3 and cassette is 24 inches. **Note: Pulse settings vary depending on imaging system.**

MATERIAL	PULSE SETTING
ENVELOPE	1
CARDBOARD BOX	2
LIGHT WOOD CONTAINER	2
HEAVY WOOD CONTAINER	5
PLASTIC BOX / APPLIANCE	5
LIGHT METAL CONTAINER	7
STEEL PIPE	15

Approximate pulse setting at 24 inches with Polaroid 803 film.

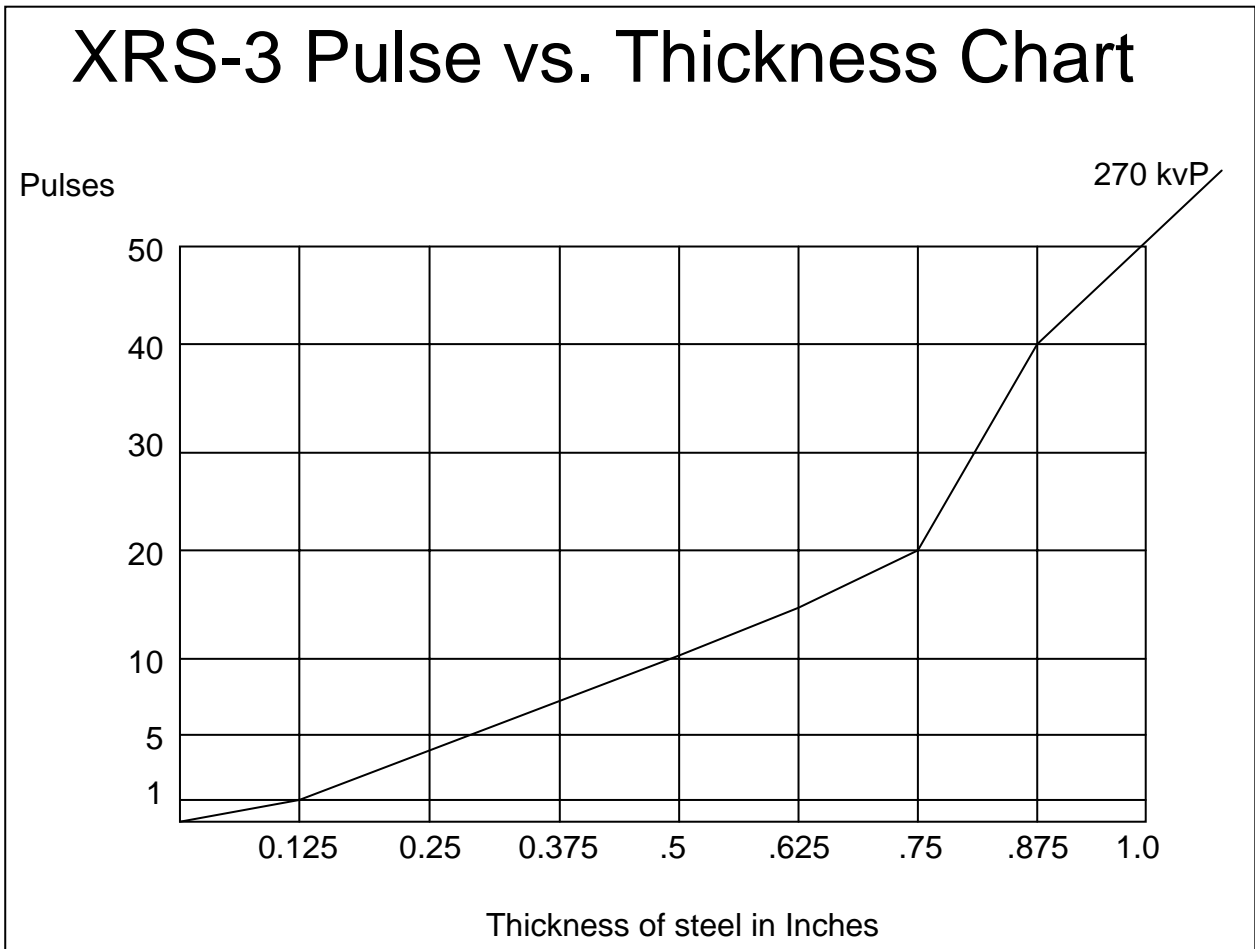

Approximate pulse settings necessary to penetrate steel at 24 inches with Polaroid 803.

The following is true when using Polaroid positive film or digital imaging system that generates a positive image. If the radiograph is too dark, the film is underexposed. If the radiograph is too light the film is overexposed. **Underexposure** can be corrected by increasing the number of pulses and/or decreasing the distance between the imaging medium (film cassette, imaging plate, or imager) and XRS-3. **Overexposure** can be corrected by reducing the number of pulses and/or increasing the distance between the imaging medium and XRS-3.

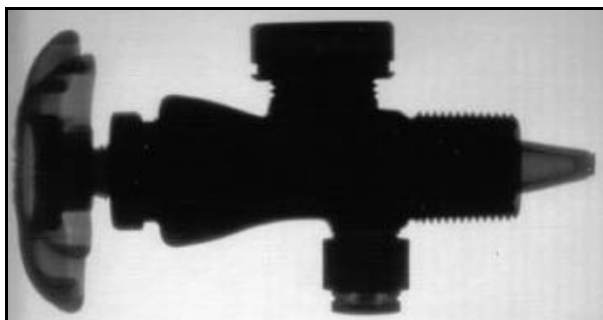

Underexposed



Overexposed



Correct exposure (pulse setting)

5.8 DUTY CYCLE WARNING. The maximum duty cycle for the XRS-3 is 200 pulses every four minutes (3000 pulses per hour). Two consecutive pulse trains of 99 pulses can be fired then the unit should rest to cool down at least four minutes. ***The XRS-3 is a light duty machine. It is not made to pulse continuously.***

6.0 SOFTWARE

The software program that controls the microcontroller can be identified by turning the key switch on while both push button switches (RANGE & UNITS) below the LCD are depressed. The LCD displays the software version "62". After "62" is displayed the total number of pulses on the XRS-3 will be displayed in the LCD. Each digit represents 10,000 pulses. Example: If the LCD reads "04" the total number of pulses on the XRS-3 is between 40,000 and 50,000 pulses. After the total number of pulses is displayed the LCD will read "00" or the default pulse setting that was last stored on the unit.

The software program is capable of determining the state of battery charge based on the time between each pulse. As the battery loses charge the XRS-3 pulses slower with more time between each pulse. If there is more than .33 seconds between two consecutive pulses the following will occur:

- The XRS-3 continues the current pulse train to “00”.
- After the XRS-3 stops pulsing, the LCD will go back to the original pulse setting, but the left and right digits will blink alternately.
- The condition indicates a low battery.
- The XRS-3 will be inoperable until the key switch is turned off and on, or the battery is replaced.

If there is more than one second between two consecutive pulses.

- The XRS-3 stops pulsing immediately and the LCD displays 00.
- This function prevents XRS-3 from pulsing continuously if there is a failure in detecting circuitry.
- This condition may indicate a low battery, electrical noise, or failure in detecting circuitry.
- The operator may need to replace the battery pack, turn key switch off and on, or send the XRS-3 back for repair.

7.0 MAINTENANCE

7.1 X-RAY DOSE MEASUREMENT Using a dosimeter, the average X-ray dose for new tube can be established.

- With the dosimeter located 1 foot from the front of the case and in line with the center of the beam angle label, the reading for 10 pulses should be 26 mR to 40 mR.
- The leakage sheet illustrates the X-ray dose and maximum allowable radiation leakage levels for each X-ray unit. A completed copy of this form accompanies each X-ray.

7.2 TUBE REPLACEMENT If you have a tube replacement kit refer to instructional disk included with the kit. If you do not have a kit the unit must be sent back to Golden Engineering or an Authorized Distributor for tube replacement. The XRS-3 tube should last at least 100,000 pulses. Under normal conditions the tube’s output will decrease slowly with use. If the tube is broken or the glass cracks the tube output will cease immediately.

8.0 TROUBLESHOOTING

SYMPTOM	TEST	ACTION
No "power on" light	-Check battery voltage -Check battery connection	- Replace or charge battery - Make sure battery is securely attached and battery clips are not bent or broken.
Power on lights, but X-ray does not pulse.	-Check the battery voltage. -Check the fuse.	-Charge or replace the battery. -Replace the fuse if necessary.
X-ray pulses, but no image or black image.	-Test X-ray output.	-Replace the tube.
Unit stops pulsing in the middle of a pulse train and LCD displays 00.	-Check the battery voltage. -Check 20 amp fuse. -Check feedback line connection.	- Charge battery if necessary. - Replace the fuse if blown. - Make sure the screw holding wire to the oscillator board.
Unit stops pulsing in the middle of a pulse train.		
Oil leaking from unit.		Return for repair.

9.0 INSTRUCTIONS FOR REPAIR

- When returning a unit for repair, include a brief description of problem incurred, contact name, phone number, and return address.
- Remove battery before shipping the unit.
- Be sure the unit is securely packaged for shipment and wrap in plastic bag if there is an oil leak.
- Ship to address:
Golden Engineering, Inc.,
6364 Means Road,
Centerville, IN 47330 USA
Phone: 1-765-855-3493

9.1 HANDLE REPLACEMENT Requires T-10 torx driver.

The Handle has two sides that are screwed together. Three screws in the handle hold it together and one screw in the base holds the handle strap together under the head.

1. Remove the 3 screws on the side of the handle.
2. Remove the base plate on the bottom of the unit.
3. Remove the screw on the bottom of the unit that holds the handle strap together.

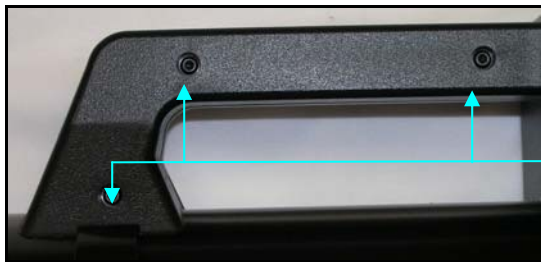

Figure 5: Handle

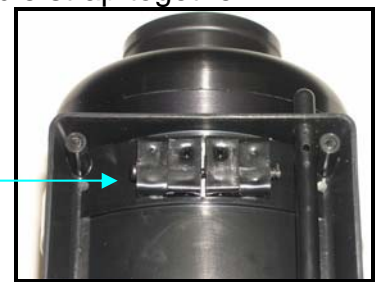

Figure 6: Handle strap base

SCREWS

4. Remove the half of the handle that is broken.
5. Place a small amount of glue on the protrusion from the control module.
6. Install new half of the handle.
7. Insert and tighten 3 screws in the handle and one screw in the handle strap.
8. Attach the base plate and insert all the screws that hold it in place.

9.2 FUSE REPLACEMENT Requires T-10 Torx driver & needle nose pliers.

1. Remove the back plate by first removing the 5 screws in the back plate then pulling the back plate off slowly maneuvering the battery terminal connecting wires through the opening in the oscillator board.
2. The 15 amp fuse is the white one inch long fuse on the left side of the oscillator board. The 3/4 amp fuse is a small green fuse just to the right of the 15 amp fuse. See diagram The 15 amp fuse can be removed with fingers. The 3/4 amp fuse may require needle nose pliers to pull it out of the board. It should be pulled in a downward direction to remove from the board.

9.3 REMOVING THE BOARDS Refer to the diagram on page 20 for steps 1-4.

1. Remove the five screws on the back plate. Remove the back plate slowly while maneuvering connection with the battery wires through the opening in the oscillator board. After the terminals are through the oscillator board, disconnect the red and black battery wires.
2. There are three terminals on the lower left side of the oscillator board and one on the lower right. Disconnect the two blue wires, one red wire, and one green signal wire using Philips head screw driver.
3. There are three socket head cap screws holding the oscillator board in place. Two are in the middle of the board and one is at the bottom. Remove these three screws. Be aware of the ½ inch stand offs behind the oscillator board.
4. Remove the flat head screw in the upper left side of the oscillator board between the two fuses.
5. Pull the board out.
6. Disconnect the oscillator board from the counter board by pulling the bottom of the oscillator board up and away from the counter board. Disconnect the two pin white key switch connector, white three pin remote connector and black touch pad connector.
7. Unscrew the LED bulb cover on the X-ray on LED.
8. Tilt the back of the counter board down until the LED clears the housing then pull the board out of the housing.

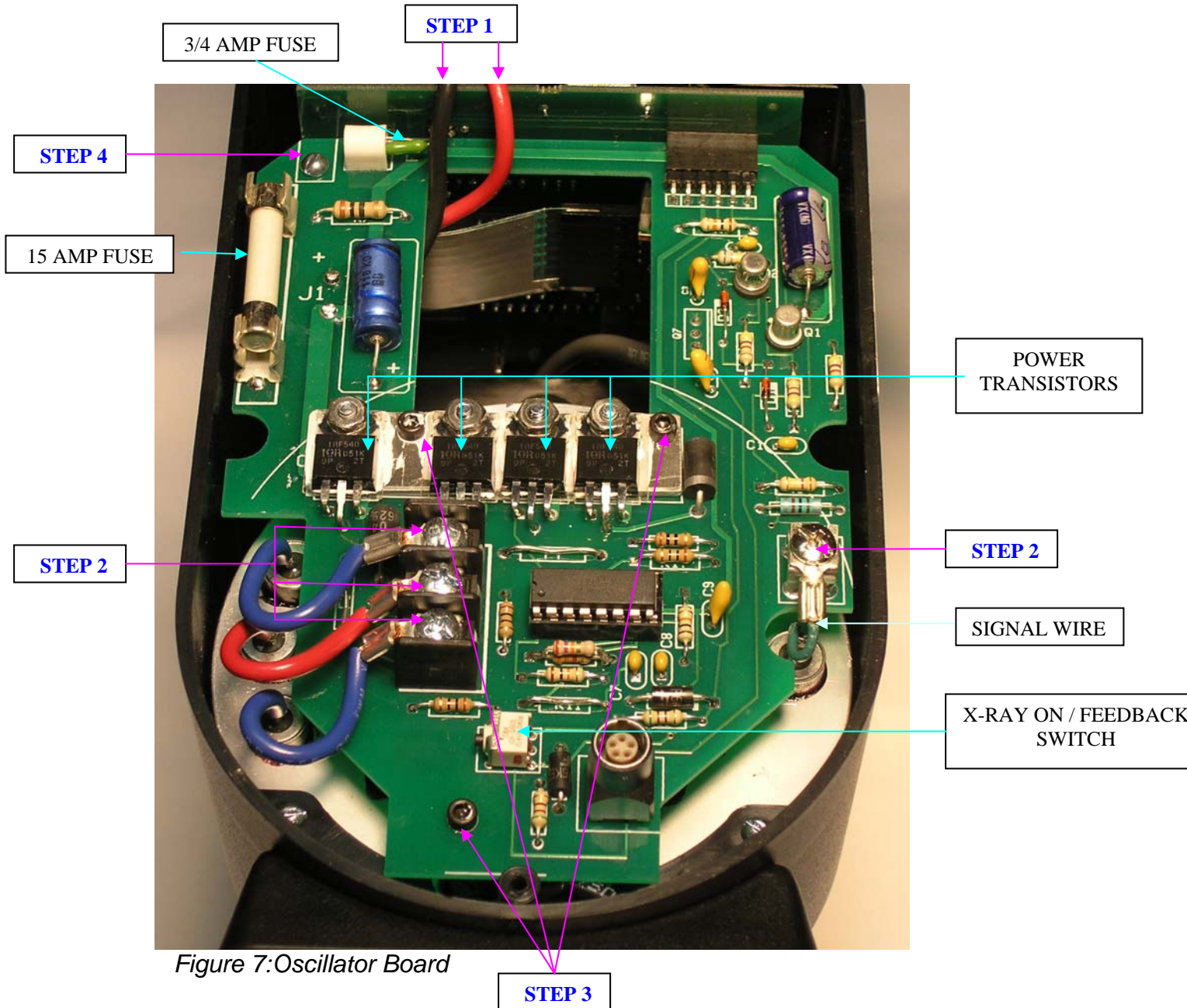

Figure 7: Oscillator Board

9.4 BOARD INSTALLATION

1. Slide counter board back into the top of the Control module housing just below the screw receptacles.
2. Push the counter board up so LED goes through the appropriate hole in the control module housing.
3. Connect the three white and one black connector.
4. Screw the LED cover back on.
5. Put the three cap screws through the oscillator board and then put the 1/2" offsets on the back of the screws.

6. Plug the oscillator board back into the counter board and push it in position.
7. Tighten the three screws holding the board in place.
8. Insert the flat head screw in upper left corner of the Oscillator board.
9. Attach the two blue wires, one red wire, and green signal line.
10. Reinstall the back plate.

9.5 HEAD REPLACEMENT Requires a small flat head screw driver.

1. Remove the boards as instructed above.
2. Remove the two screws on the bottom that attach the head to the control module.
3. Remove the screw on the upper left side of the head. Must rotate head slightly and put the screw driver through the left LED hole to remove the screw.
4. Pull the head straight out of the control module. You might need to loosen the screw in the handle to get the head out.

9.6 INSTRUCTIONS FOR BATTERY DISPOSAL Follow all federal, state, and local laws for disposal of nickel-cadmium batteries. Batteries may be returned to Golden Engineering for disposal.

10.0 WARRANTY

Certification of Warranty

XRS-3 Serial Number _____
Battery Charger Serial Number _____
150P Processor Serial Number _____
4"x5" Cassette/Developer Serial Number _____
Date Delivered _____

Unit Warranty

Golden Engineering, Inc. warrants XRS-3 X-ray unit made and sold by it or its authorized representatives to be free of defects in materials and workmanship for a period of twelve (12) months from the date of shipment to the end user. To make a claim under this limited warranty, customer must ship the entire unit (or the component believed to be defective) to Golden Engineering, post-paid. Golden Engineering, Inc. assumes no liability for units or components shipped until they are actually in the custody of Golden Engineering, Inc. Provided Golden Engineering, Inc. in its sole discretion, is satisfied that the defect is not the result of abuse, misuse, accident, modification or improper disassembly or repair, Golden Engineering, Inc. reserves the right to use reconditioned and remanufactured components that meet original specifications. The unit or component will be return shipped to customer at customer's expense. THIS EXPRESS LIMITED WARRANTY IS IN LIEU OF ALL OTHER WARRANTIES AND GUARANTEES, EITHER EXPRESS OR IMPLIED OR CREATED BY OPERATION OF LAW.

THE XRS-3 X-Ray Source is manufactured by:

GOLDEN ENGINEERING, INC.

PO BOX 185

CENTERVILLE, IN 47330 USA

Phone: 1-765/855-3493

Fax: 1-765/855-3492

WEB: www.goldenengineering.com

11.0 SPECIFICATIONS

11.1 PHYSICAL DIMENSIONS INCLUDING BATTERY PACK:

Length.....	14 inches (31.8 cm)
Width.....	4.5 inches (11.5 cm)
Height.....	7.5 inches (10 cm)
Weight.....	12 pounds (5.5 Kg) with battery

11.2 X-RAY OUTPUT.

X-ray dose per pulse.....	2.6 mR to 4.0 mR (.026-.04 mSv)*
Number of pulses per battery charge.....	4000.
Number of pulses per second.....	15 (nominal).
Expected life of XRS-3.....	100,000 pulses minimum.
X-ray source size.....	1/8 in. (3 mm)
Maximum photon energy.....	270 KVP.
X-ray pulse width.....	60 nanoseconds. (.00000006 seconds)

* Measured 12 inches (30 cm) in front of the unit.

11.3 ELECTRICAL AND THERMAL CHARACTERISTICS.

Battery Voltage.....	14.4 volts.
Battery Type.....	Nickel Cadmium sub C cells.
Battery recharge time.....	One hour.
Battery Charger.....	DeWalt DW9116 or DE9108 one hour charger.
Current draw.....	35 amps @ 13.4 volts.
Temperature range.....	-10 to 120 degrees F. (-23 to 50 degrees C)
Maximum duty cycle.....	200 pulses every 4 minutes. (3000 pulses per hour)
Warm-up.....	None required.

11.4 X-RAY LEAKAGE

X-ray leakage 25 mR per 100 pulses maximum
on the side of the unit, 3 inches from the center of the unit. 2 mR per 100
pulses 2 inches behind the unit.

SPARE PARTS AND ACCESSORIES FOR THE XRS-3

ITEM	PART#
Thumbwheel Key.....	5951020
Flat key.....	5951040
DeWalt Battery DC9091	4100030
DeWalt battery charger (110V) DW9116	4100040
DeWalt battery charger (220V) DE9108.....	4100050
Remote cable.....	2006050
Tripod mount.....	2008010
Handle - left side.....	4004020
Handle – right side.....	4004021
Small Pelican® carrying case (holds X-ray, two batteries, charger, cable)..	4001635
Large carrying case (holds X-ray, accessories, 150P film system).....	4001670