

Acceptance Levels of Weld Defects for Fatigue Service

The derivation and use of standards for the acceptance of defects in welded joints undergoing fatigue loading is considered with fitness for purpose as a major criterion

BY C. F. BOULTON

Introduction

The rapid development of nondestructive testing (NDT) techniques and the improvement in operator efficiency that has occurred in recent years have resulted in more and more weld defects being located. In existing fabrication standards, the basis of acceptance criteria for weld defects appears to be arbitrary. Generally, such standards demand one universal level of quality, regardless of the service conditions of the joints in question.

Research has shown that all welded joints will contain flaws; whether or not they are detected will depend upon the sensitivity of the NDT method employed. Clearly the removal of such flaws may be unnecessary and the use of a standard which demands their removal becomes ridiculous—particularly when, with the aid of hindsight, it is known that welded joints containing the very same flaws have behaved perfectly satisfactorily in service, and no one has been concerned with their presence as no one had detected them. Because of this, emphasis is now being placed on defect acceptance based upon a “fitness for purpose” approach whereby flaws which could not give rise to premature failure of the structure or joint in question are left intact.

Despite the above comments it can be argued that very few structures which have been inspected to existing arbitrary codes have failed. Moreover, it would be difficult to establish that those which had failed had done so specifically because of the weld acceptance standard employed. The question is thus posed: Why is there any need to change?

The arguments for adopting realistic acceptance standards are two-fold. The first is economic. Salter and Gethin (Ref. 1) have carried out a survey of repairs actually carried out to

the main seams of pressure vessels by a number of British fabricators. They found that 87% of weld metal removed was to eliminate three dimensional weld defects (84% for slag inclusions, 3% for porosity). Based on a fitness for purpose assessment, all these defects would have been considered acceptable. The remaining 13% of weld metal was removed to eliminate two-dimensional (planar) defects, of which some but not all were considered unacceptable based on fitness for purpose. The cost involved in making unnecessary repairs does not need to be expounded here.

Of greater technical importance, the repair of harmless three-dimensional defects may introduce more harmful, and less easily detectable, planar defects. Repair welding is often difficult to carry out satisfactorily since the repair welds are usually not made under such favorable conditions as were present when the original weld was deposited. For example, repair welds must often be made under conditions of difficult access or high restraint. The introduction of cracking while repairing harmless defects has been reported by Lundin (Ref. 2). On the other hand, failures from small, apparently innocuous defects have initiated failures (Refs. 3, 4). Thus there is ample evidence that, based on “fitness for purpose”, acceptance standards could be relaxed, but also should be tightened up in certain areas.

The literature on the effect of weld defects on service performance is vast and steadily increasing. It is a major task to interpret and edit this informa-

tion in such a way that it can be readily used to quantify the effects of the presence of weld defects on structural integrity. However, a major step in this direction has now been taken by the British Standards Institution (BSI), whose specialist committee dealing with the subject issued a draft document for public comment entitled “Draft Standard Rules for the Derivation of Acceptance Levels for Defects in Fusion Welded Joints” (Ref. 5).

It is not the purpose of this paper to review the contents of the draft document; for this the reader is referred to a paper by Burdekin (Ref. 6). Operation of defect acceptance based on fitness for purpose obviously necessitates some means of establishing the effect of a particular defect on the strength or integrity of a welded joint. This paper deals with the derivation of acceptance levels of weld defects operating under fatigue conditions, which is one of the primary failure mechanisms. The defects considered comprise those most commonly encountered and can be categorized under one of the following headings:

1. Three-dimensional (non-planar) defects: (a) solid inclusions (slag); (b) gas pores.

2. Two-dimensional (planar) defects: (a) cracks; (b) lack of penetration/fusion.

The recommendations presented in the paper regarding defect severity are based primarily upon the results of laboratory testing and experience for non-planar defects and on fracture mechanics principles for planar defects. It is hoped that the information given will be of assistance to fabricators, designers and licensing authorities in the determination of which flaws can be accepted without impairing structural integrity. To this end the information has been presented in such a way that fatigue strength estimates can be made by personnel with

Paper presented at the AWS 57th Annual Meeting held in St. Louis, Missouri, during May 10-14, 1976.

C. F. BOULTON is Senior Research Engineer, The Welding Institute, Abington, Cambridge, England.

a minimum knowledge of the fatigue process itself. The assistance of fatigue researchers and fracture mechanics experts will not be required, provided the simple guidelines laid down are followed.

Most of the data here refers to structural C-Mn steels operating in ambient temperature air environments; however, the principles described should be applicable to any material/environment combination. Methods of taking into account other material/environment combinations are discussed.

The fatigue strength of each part of a structure will, as often as not, be decided by the lowest fatigue strength joint within that member. This being the case, there is little point in requiring a defect-free butt-weld if it is situated within a global stress field which also encompasses, for example, a load-carrying fillet weld which will exhibit a much lower fatigue strength. Acceptance levels of weld defects within a structure must, therefore, be related to the fatigue strength of other joints within that structure.

In many cases, it is obviously unnecessary to insist upon perfection for many welds within a structure and quality standards geared to real service requirements can show considerable economic return for a company. However, it must be stressed that the adoption of defect acceptance standards based on fitness for purpose does not imply that a general lowering in the original quality of welds is acceptable.

In general, it costs little more to make welds which are relatively defect-free than it does to make defective welds. Thus, defect acceptance standards are intended to be used to decide whether or not to repair or reject a particular structure when a particular defect happens to be present as a result, for example, of human error. If a structure contains many defects, it is clear that something radical may be wrong with the fabrication procedure which the fabricator, himself, should investigate.

Philosophy of Flaw Assessment

The conventional method of representing the fatigue properties of many welded joints lies in the use of the S-N diagram where, for a given material and joint type, the applied stress is plotted against endurance. Implicit in the use of S-N curves for data representation is the fact that all the relevant variables for a particular type of joint in a particular material remain approximately constant. Given these conditions, scatter in fatigue data may be taken into account by statistical analysis, whereby a lower confidence limit of data can be specified. By such means a design curve to avoid fatigue failure can be established.

The philosophy behind the derivation of acceptance levels for non-planar weld defects (slag, porosity) lies in the concept of the S-N diagram.

Both types of defect can be categorized in terms of severity by simple geometric measurements—in the case of slag inclusions, in terms of depth and length and for porosity in terms of volume. Thus, comparisons between the expected fatigue life of the defective joint, the fatigue lives of other welded details present and the required service life can be made easily.

A considerable volume of research has been carried out worldwide into the effect of non-planar weld defects on fatigue behavior. The first attempt to survey and codify the results was made by Harrison (Ref. 7, 8). He divided the S-N diagram into a number of arbitrary areas, termed "Quality Bands", whereby each band was taken to represent a certain quality requirement. In fact five quality bands labelled V-Z were chosen, although more or fewer could have been used. In this arrangement category V permits no flaws, while increasing flaw size is permitted through categories W to Z. The quality bands are separated by lines drawn at a slope of $-1/4$, which fitted the fatigue crack propagation law proposed at the time and conformed with an earlier theory (Ref. 9) developed to quantify the presence of lack of penetration defects in terms of fatigue strength.

This slope is now known to be incorrect but, since it does fit the results of tests carried out on three-dimensional defects, it has been retained in the Draft British Standard (Ref. 5). For non-planar defects the procedure adopted to arrive at the permissible defect size for each of the quality areas was to plot results taken from the worldwide literature for defects of gradually increasing size on to the S-N diagram containing the quality bands. The permissible defect size for each area was taken as that for which one or more results first fall into

Table 1—Nomenclature

- a - Crack length
- a_i - Initial crack length or flaw size
- a_f - Final crack length for failure
- C - Constant in equation describing fatigue crack propagation
- C_R - Constant in hypothetical equation accounting for crack propagation in an aggressive environment.
- D - Constant in equation describing S-N data
- D_R - Constant in equation describing S-N data in aggressive environment
- E - Young's modulus of elasticity
- I - Constant representing value of integral $\int_{a_i}^{a_f} da / (Y\sqrt{\pi a})^m$
- K_{Ic} - Plane strain fracture toughness
- m - Exponent in equation describing fatigue crack propagation. Represents the slope of the data.
- n - Exponent in equation describing S-N data. Represents the slope of the data.
- N - Fatigue life, also termed endurance and cycles to failure
- V, W, X, Y, Z - Designated quality bands for defect acceptance
- Y - Variable depending upon geometry of a fatigue crack
- da/dN - Rate of fatigue crack propagation
- HAZ - Weld heat-affected zone
- SCF - Stress concentration factor
- S-N - Representation of fatigue data in terms of stress, S, and cycles to failure, N.
- ΔK - Range of stress intensity factor
- $\Delta \gamma$ - Total range of strain
- $\Delta \sigma$ - Total range of stress

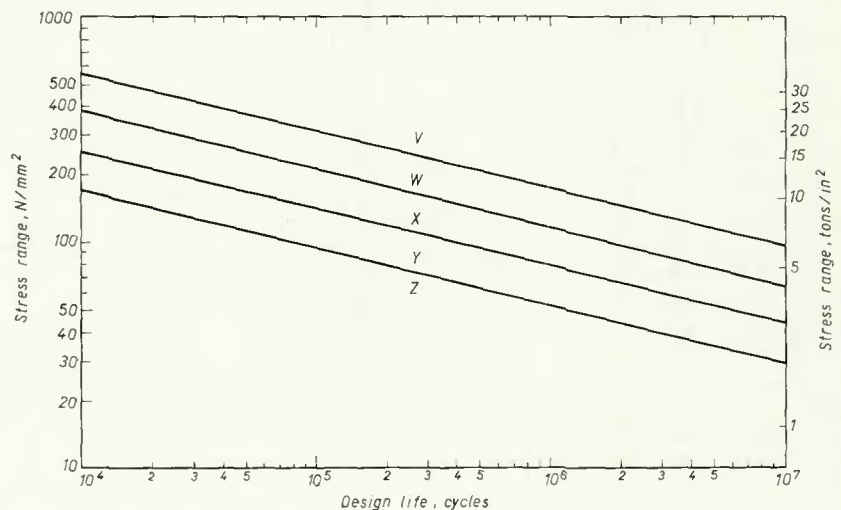

Fig. 1—Quality bands for defect acceptance

the area.

The quality bands are depicted on the S-N diagram in Fig. 1, and the stresses corresponding to fatigue life at 10^5 and 2×10^6 cycles are given in Table 2. It should be mentioned that these values are as originally proposed by Harrison *et al* (Ref. 10). To introduce further conservatism into acceptance levels for use in the Draft British Standard, the stresses given in Table 2 have been factored by 0.88. However, in this paper reference will be made to the quality bands as originally proposed, and it will be shown that these are conservative in themselves. As can be seen in Fig. 1, quality V has no upper limit; this is why it is necessary to stipulate that no defects can be tolerated.

Three Dimensional Defects

The results of fatigue tests on joints containing porosity classified the severity of such defects in terms of percentage by volume, which can be taken to be approximately equal to percentage on a cross section. The permissible levels detailed in Table 3(a) were then derived by plotting the results as described to determine the critical defect size for each quality band.

At this point, it will be appreciated that porosity is an innocuous defect from the point of view of fatigue and will only have a significant effect if present in very large amounts. However, there is a danger that porosity in such high levels could mask the presence of other, more harmful, defects; for this reason, it was decided to limit porosity to lower levels to make inspection possible. It was, in fact, decided to work on a basis of the percentage of projected area as shown on a radiograph, and the proposed levels are given in Table 3(b). They are considerably more lenient than those allowed in existing codes.

A similar approach was adopted to codify the results of tests on joints containing slag inclusions. For this type of defect the severity parameter selected was defect length. Although the choice of such a parameter may seem irrational on a theoretical basis in that fracture mechanics analyses

would specify the depth through the thickness as the relevant severity characterizing parameter, the choice is justified on empirical grounds since the depth will not vary widely in practice so that the full range of likely depths will have been covered in the tests.

Categorization of fatigue test results on this basis has proved satisfactory (Ref. 8) and defect length is the most readily measured dimension. Results from the literature indicate that fatigue strength falls quite rapidly with increasing slag length, but once the defect exceeds 10–20 mm there is little change. It has also been found that stress relief improves the fatigue strength of slag-bearing welds, mainly because it removes hydrogen which is deleterious to strength, and therefore as-welded and stress-relieved joints may be separately categorized. The proposed acceptance levels for slag inclusions are detailed in Table 3(c).

As indicated previously, a high proportion of all weld defects detected are not cracks (Ref. 1). Thus, relaxation of acceptance requirements for three-dimensional defects should yield considerable economic returns. The safety of the quality levels proposed for these defects types has been partially confirmed by Soete and Sys (Ref. 11) in tests on large model pressure vessels and recently received further confirmation (Ref. 12).

Planar Defects

An approach similar to that for three-dimensional flaws cannot be used to categorize planar flaws. Planar defects can include the following: cracks, lack of penetration, lack of fusion, lack of interrun fusion, lack of root fusion, lack of sidewall fusion and oxide inclusions in aluminum welds. Undercut and root concavity can also be treated as defects breaking the surface, since they will certainly contain small crack-like defects at their roots.

In the past, it has been conventional to reject, with a few exceptions, welds containing planar defects and such an approach appears reasonable when such defects are known to be the most deleterious. However, it is known that virtually all welded joints contain planar defects of one kind or another, but most are small enough to escape detection. Structures containing such defects have given quite satisfactory service.

With improvements in NDT techniques and the increasing use of destructive examination of sample welds, it becomes clear that a standard which seeks to reject all planar flaws is no longer practical. A decision must, therefore, be taken as to whether the defect is large enough to impair the serviceability of the structure. The severity of planar flaws depends not only on size but also on shape and location, all of which may vary from one weld to the next. Since it would obviously be impossible to test all combinations of joint type, defect size and position to obtain normal S-N data, fracture mechanics analysis techniques must be used to quantify the effects of planar defects.

Harrison (Ref. 9) showed how it was possible to analyze the results of fatigue tests on butt welded specimens containing two dimensional planar flaws by integrating the fracture mechanics based fatigue crack propagation law (see Table 1 for nomenclature):

$$da/dN = C (\Delta K)^m \quad (1)$$

Harrison took the value of m as 4 and found that this fitted the results. In the Draft British Standard (Ref. 5), a simplified version of Harrison's method of analysis is given for general use. This approach has been published previously (Ref. 13) and is well tried and proven against laboratory data for fatigue tests on welds containing planar defects. The method is based upon the use of equation (1), with a fixed value of $m = 4$ and the value of

Table 2—Values of Stress and Cycles for the Quality Band System of Defect Acceptance

Line dividing quality bands	Stress (N/mm ²) at	
	10 ⁵ cycles	2 × 10 ⁶ cycles
V-W	309	142
W-X	208	96
X-Y	139	65
Y-Z	93	43

Table 3—Permissible Levels of Defects for the Quality Band System of Defect Acceptance

Quality	V	W	X	Y	Z
(a) Porosity as proposed by Harrison <i>et al</i> (Ref. 10)					
Permissible % of porosity by volume	0	3	8	20	20
(b) Porosity as proposed in the Draft Standard (Ref. 5)					
Permissible % of projected area on radiograph	0	3	5	5	5
(c) Slag inclusions as proposed by Harrison <i>et al</i> (Ref. 10) and the Draft Standard (Ref. 5)					
Inclusion length, mm, (Max) as-welded	0	1.5	10	No maximum	No maximum
Inclusion length, mm, (Max) stress-relieved	0	6.0	No maximum	No maximum	No maximum

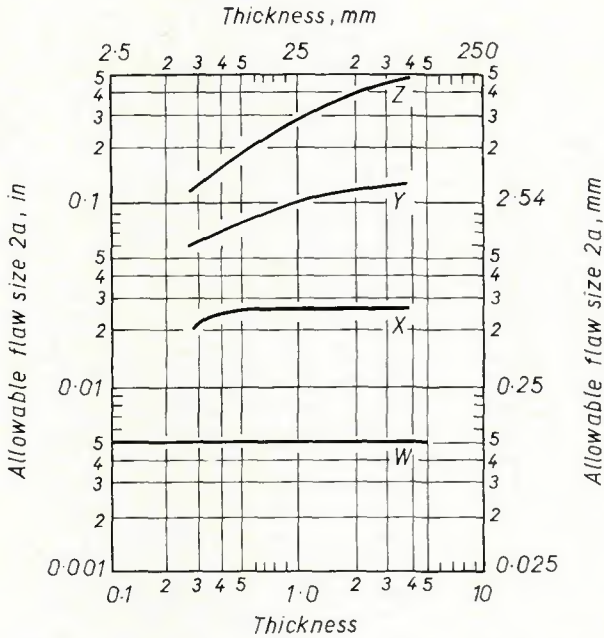

Fig. 2—Allowable sizes of two dimensional defect plotted against thicknesses for the various fatigue quality levels

the constant C chosen so that the analysis gives conservative results against all known laboratory test results.

The crack propagation equation is integrated, and the results are presented in graphical form. This is done such that, for each of the quality levels V-Z, the maximum allowable flaw size can be determined as a function of thickness. This presentation is shown in Fig. 2. The curves apply to the total depths of long buried flaws, but methods are given to assess and re-categorize planar defects if they occur at the surface and if they occur as flaws in the stress concentration region of a fillet weld, i.e., the weld toe.

If flaw length is less than 10X the depth, then the depth may be re-categorized to take account of the less severe defect aspect ratio by allowing an increase in depth. This re-categorization is shown in Fig. 3. The fatigue life is calculated to the stage where the defect becomes a through thickness crack (for pressure vessel applications, this is the "leak before break" situation). If the fracture toughness and stress conditions are such that final fracture would occur from a fatigue crack smaller than through thickness, this can be allowed for by calculating the life from this crack size to the full-thickness, and then deducting this number of cycles from the total life to the full thickness crack. This correction is usually small.

Analyses are also given for flaws at fillet weld toes for different ratios of fillet size to plate thickness. The small values of allowable flaw size so calculated are indicative of the very large effect which toe cracks or undercut

may have on fatigue life.

Recategorization of planar defects in terms of size may also be necessary if adjacent flaws will interact. Harrison (Ref. 9) has shown that interaction cannot occur if the length of sound metal between the ends of two adjacent defects is greater than: (a) 2.25 times the thickness of the material and (b) 1.25 times the length of the larger defect.

It is, therefore, stipulated that provided these limitations apply, each defect may be treated separately. If, however, either of these limitations are exceeded, the Draht specifies that the defects should be re-categorized in size by a rectangle which includes the interacting defects. This rectangle should be drawn such that its sides are parallel and at right angles to the plate surfaces. This rule also applies to adjacent, discontinuous slag inclusions.

Defect Acceptance Under Low Cycle Fatigue Conditions and in Aggressive Environments

The majority of the test data from which the rules were developed were obtained under high cycle ($>10^6$) fatigue conditions. Bearing in mind that the Standard had to cater for defects in all types of structures, including pressure vessels, it was necessary to demonstrate that the methods of deriving acceptable defect levels would cover weld defects operating under low cycle fatigue conditions. This held particularly for defects situated in regions of high stress concentration such as nozzle joints in pressure vessels. There was also virtually no published data dealing

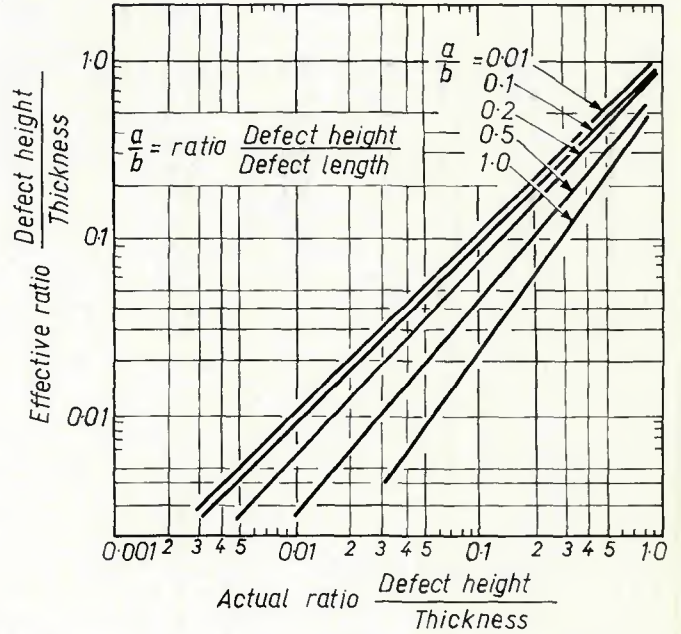

Fig. 3—Reduction in defect height permitted for "short" defects

with the effects of other than ambient temperature air environments on the fatigue behavior of joints containing weld defects; consequently, no guidance could be given as to how to assess the behavior of defects in other environments.

One of the most important functions of the research worker in this area is to supply the required data obtained from small-scale laboratory tests. Another function is to generate confidence by demonstrating that the information can be safely applied to real structures. With these objectives in mind, The Welding Institute has carried out a major project (Ref. 14), sponsored by a number of industrial concerns, to provide the data and analyses necessary to assess the behavior of weld defects under low cycle and aggressive environmental conditions. This project was outlined by Archer (Ref. 12), prior to its completion, but is now described below with test results and analyses relevant to the derivation of acceptance levels for defects operating under the aforesaid conditions. Test results are given in SI units, but a list of conversions to customary U.S. units is included in Table 4.

Low Cycle Fatigue

The problem of assessing weld defects under low cycle fatigue conditions was tackled using two methods. Butt welded specimens containing actual buried defects, (porosity, slag and lack of penetration) were fabricated from a mild steel to BS 1501-161 and a low alloy steel to BS 1501-271. These materials were chosen to cover the range of steels in current use for

Table 4—List of Conversions from SI to U.S. Customary Units

Unit	SI	U.S. customary	Conversion
Length	mm	inch	25.4 mm = 1 inch
Stress	N/mm ²	Ksi	6.89N/mm ² = 1 Ksi
Stress Intensity	Nmm ^{-3/2}	Ksi√inch	34.7N mm ^{-3/2} = 1 Ksi√inch

pressure vessel applications.

The specimen design used is shown in Fig. 4, and specimens were tested under predominantly high strain conditions. It is worth mentioning that current pressure vessel code requirements permit strain ranges of up to twice yield to occur in nozzle welds; to simulate this situation, the strain range across the defective weld was varied up to twice yield. As a fatigue crack grows under strain controlled conditions, the applied load required to maintain the strain range will fall. As this is the case, the failure criterion adopted for these specimens was either the development of a through-thickness crack, or a 60% fall off in upper limit load, whichever occurred first.

For tests on specimens containing non-planar defects, two levels of defect severity were produced:

1. For porosity, 1% of the projected area per 25 mm of weld thickness based on radiographic measurements (this being the maximum level allowed by the ASME code—Ref. 15) and 3% by volume.

2. For slag, a continuous slag line and 3 slag inclusions approximately 6 mm in length spaced 30 mm apart so that no defect interaction would take place.

The results obtained were plotted on an S-N diagram on which the quality bands had been linearly extrapolated into the low cycle regime. The S-N diagram utilized differed from that originally proposed in that the stress range was replaced by the total strain range, calculated as:

$$\Delta\gamma = \Delta\sigma / E \quad (2)$$

where $\Delta\gamma$ = strain, $\Delta\sigma$ = stress and E = Young's modulus.

The results so obtained are shown in Fig. 5 for specimens containing porosity and in Figs. 6 and 7 for specimens containing continuous and intermittent slag respectively. As can be seen, all the results fell in quality bands higher than those proposed (see Tables 1 and 2) for the severity of defect. The net result of this work was to demonstrate that the quality band

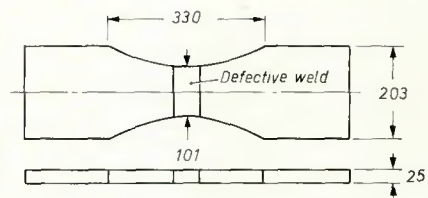

Fig. 4—Design of specimens with defective butt welds to assess low cycle fatigue behavior. Dimensions in mm

system proposed by Harrison et al (Ref. 10) can be extrapolated to endure

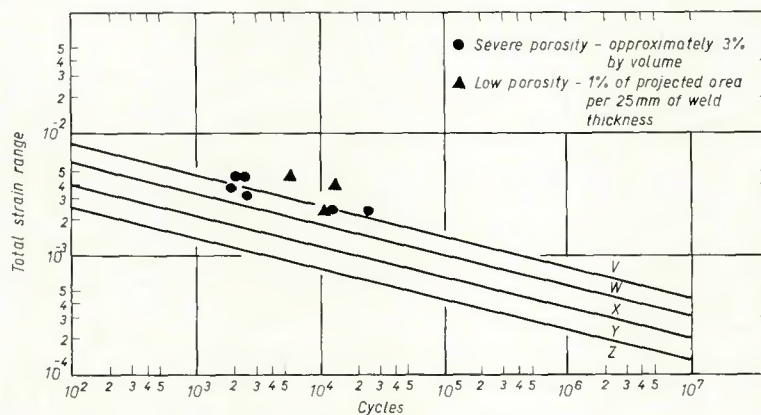

Fig. 5—Results of tests on specimens containing porosity defects

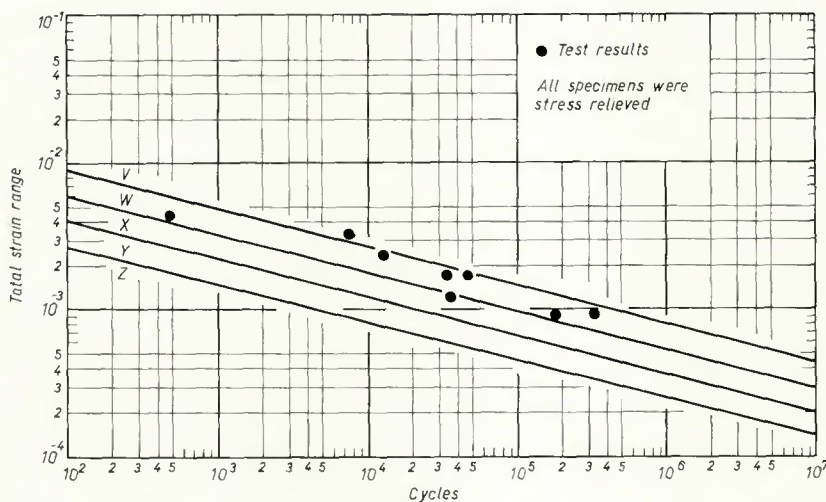

Fig. 6—Results of tests on welded specimens with continuous slag inclusions

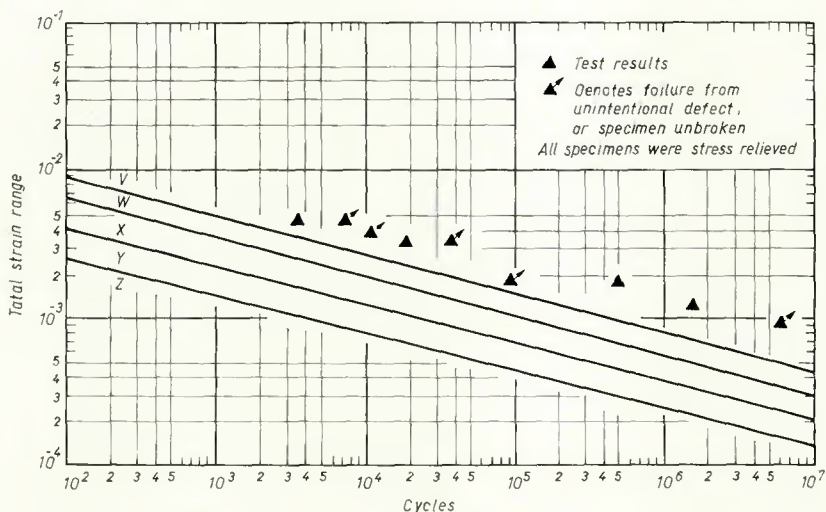

Fig. 7—Results of tests on welded specimens containing 3 slag defects (approximate length 6 mm)

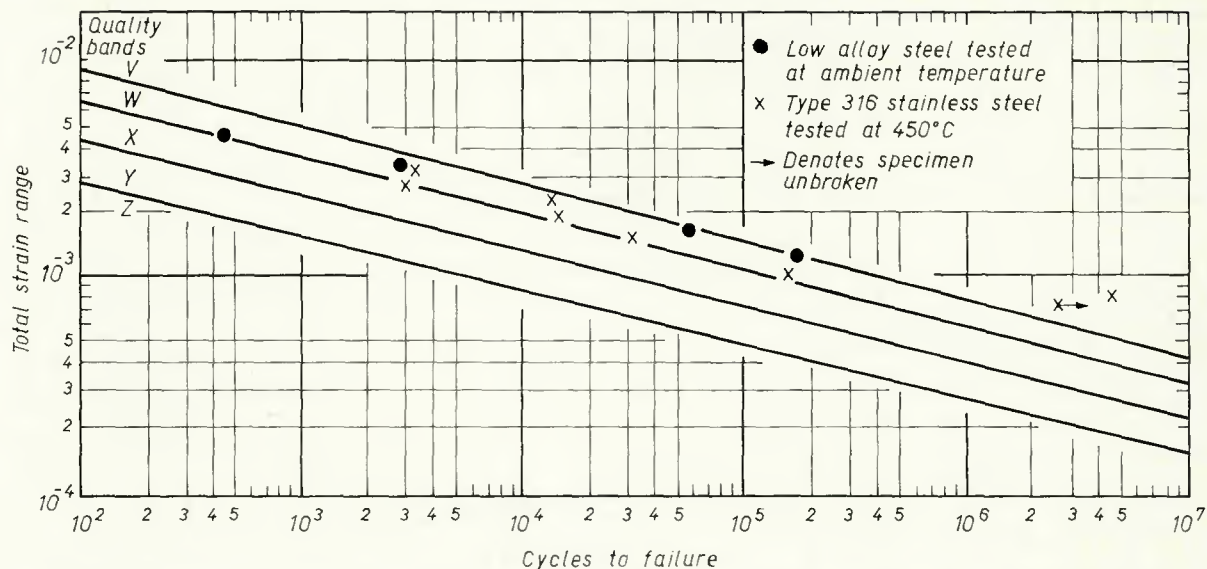
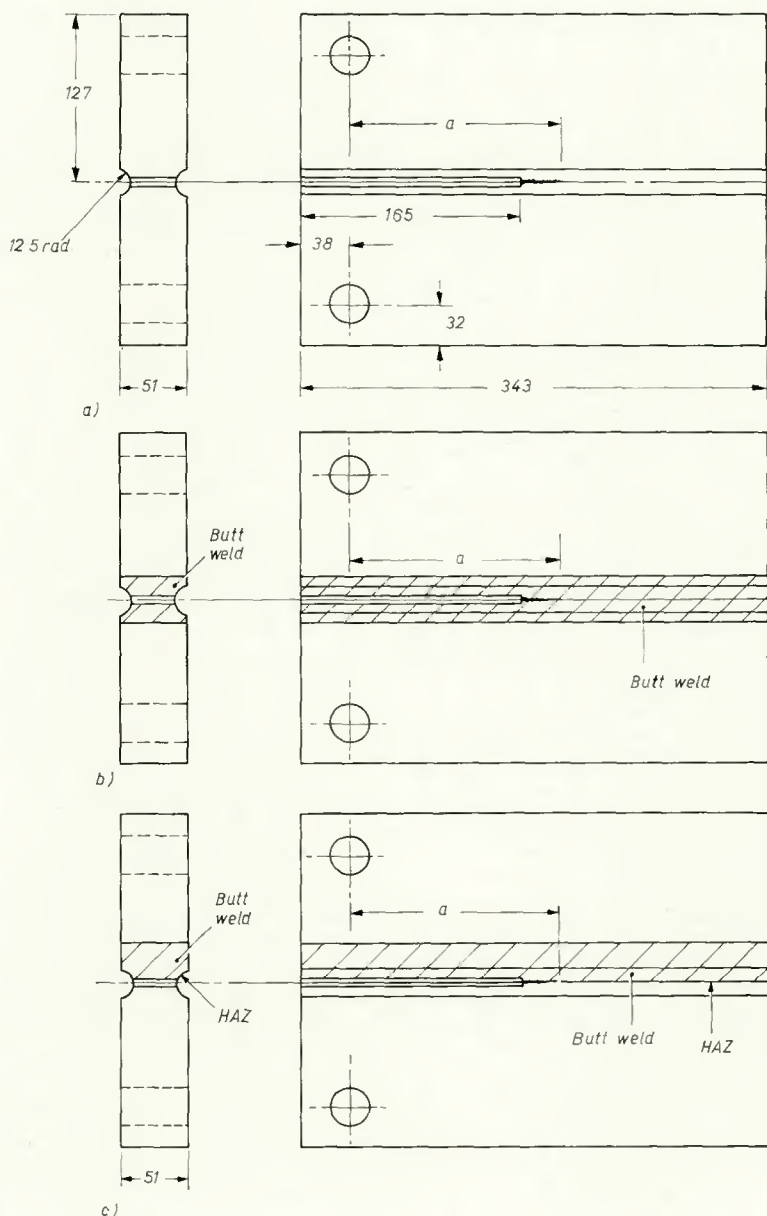

Fig. 8—Results of tests on welded specimens containing lack of penetration defects tested at ambient and elevated temperatures



ances as low as 500 cycles if strain range replaces stress range on the S-N diagram.

Similar specimens containing central buried lack of penetration defects were also tested under low cycle fatigue conditions. In this case the defects were approximately 25 mm long by 8 mm deep. The results obtained are shown in Fig. 8 where it can be seen that they fell within quality band W. The fracture mechanics based analysis given in Figs. 2 and 3 would deem these defects acceptable to quality Z. Thus, once again the proposed acceptance standard was shown to be conservative. It is worth noting that none of the present fabrication codes would deem these defects acceptable.

Harrison (Ref. 9) showed that it was possible to predict the behavior of butt joints containing planar defects by fracture mechanics analysis techniques. His analyses referred to defects operating under high cycle conditions. To carry out similar analyses of defective joints operating in the low cycle regime, crack propagation studies were carried out at very high stress intensity factor ranges typical of those which would be present at defective nozzle welds.

The type of specimen utilized in these tests is shown in Fig. 9. It was found that fatigue crack growth rates tended to be lower in the weld regions than the base metal for the two materials tested, the growth rate in the HAZ being the lowest. For this reason it is suggested that fracture mechanics assessment of crack growth from

Fig. 9—Design of crack propagation specimen to measure growth rates at high stress intensity levels in: a) base metal b) weld metal; c) HAZ

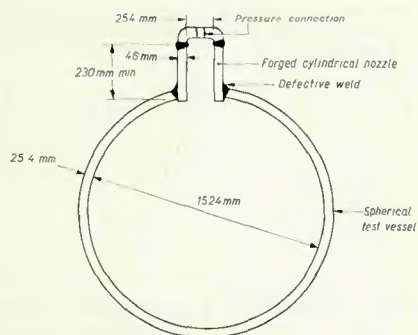

Fig. 10—Design of spherical test vessel to study: a) slag; b) porosity; c) lack of penetration defects in stress concentration regions

planar weld defects by fatigue is carried out using growth data for the base metal. The scatterband of crack propagation data, which except at very high values of ΔK was relevant to propagation under plane strain conditions, lay on a linear extrapolation of data obtained at lower values of ΔK by Maddox (Ref. 16) and was essentially linear up to very high ΔK values ($6000 \text{ Nmm}^{-3/2}$).

To generate confidence in the use of the quality band system and small scale tests to determine acceptable defect levels, particularly under low cycle fatigue conditions, tests were also carried out on model pressure vessels; these were fabricated from the same mild and low alloy steels as were used in the small scale tests.

The vessel design used for studying the behavior of weld defects in stress concentration regions is shown in Fig. 10. Defects (slag, porosity and lack of penetration) were situated in the nozzle welds. The opening was reinforced to current code requirements with the reinforcement in the nozzle for experimental reasons. A cylinder/sphere intersection was chosen since it was more amenable to a theoretical crack propagation analysis than a cylinder/cylinder intersection.

The weld design selected involved only a very small external fillet, about 3 mm. For this design a finite element analysis of the defect free joint gave a peak stress concentration factor (SCF) of about 2.1 in the radial direction (perpendicular to the weld) and about 1.9 in the meridional direction. In both cases these were in the weld area. By increasing the fillet size to a more realistic 12 mm, these SCFs could both have been reduced to 1.8. However, the small fillet size was used in the tests in an attempt to ensure that failure would occur in the defective nozzle welds.

The vessels were subjected to a hydrostatic test before cyclic pressure loading, and the hoop stresses for the static and cyclic tests were the

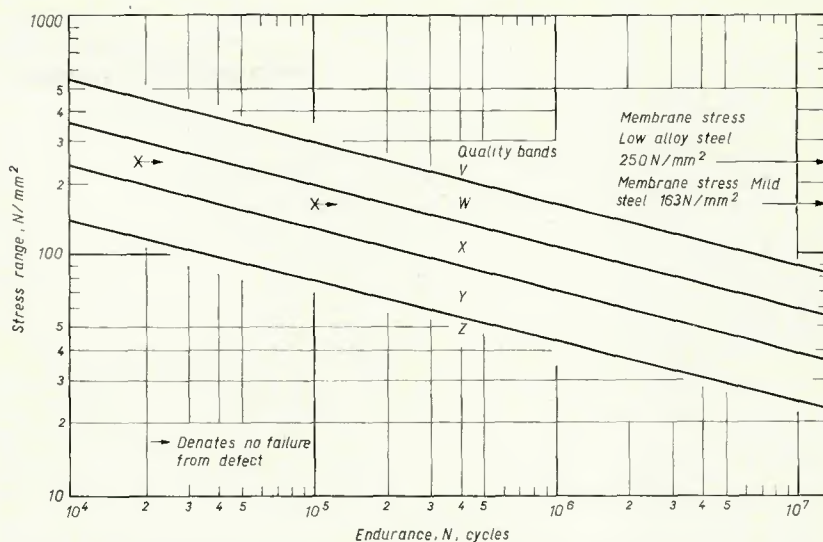

Fig. 11—Results of tests on nozzle welds containing slag defects compared with acceptance proposals: W—as welded, 1.5 mm max. stress relieved, 6 mm max.; X—as welded, 10 mm max. stress relieved, no maximum; Y—no maximum; Z—no maximum

maximum which BS 1515 (Ref. 17) would allow for the materials, the cyclic stresses being 163 and 250 N/mm^2 respectively. Bearing in mind that intermittent slag had been shown to be a virtually innocuous defect in the small scale tests, only continuous slag defects were introduced into the nozzle welds. These slag lines extended around the complete periphery of the weld. Neither of the nozzle welds failed from the slag-line defects. In the mild steel vessel the test was stopped after more than 100,000 cycles at which stage no crack growth from the defect was evident. In the low alloy steel vessel, failure occurred from one of the main seams in the vessel after 19,000 cycles. This seam weld failure was associated with joint misalignment.

The two results are plotted in Fig. 11 together with the proposed quality bands. Although these results have been plotted in terms of vessel membrane stress, no account being taken of the localized stress concentration due to the nozzle geometry, it may be seen that the proposed acceptance levels are still conservative.

Two vessels containing severe porosity were tested, one in each of the materials. The defective nozzle weld in the low alloy steel vessel failed after only 1,130 cycles, the nozzle being completely blown off the vessel. After failure, the porosity level was found to be 9.4% by volume. The main reason for the early failure, however, was the gross lack of fusion also present which covered about 50% of the fracture face; this was presumably due to the extreme measures taken to produce the porosity defects. In view of the gross porosity and lack of fusion, the

failure was probably due to overloading rather than fatigue.

This result did highlight the dangers, mentioned earlier, of gross porosity masking more harmful planar defects. The defective nozzle weld in the mild steel vessel failed after 24,000 cycles. After failure it was found that the porosity level was 7% by volume. This result demonstrated that the proposed acceptance levels were safe providing that account was taken of the increase in stress due to the stress concentration at the nozzle. These results indicate that levels of porosity as high as 7–10% by volume are dangerous in stress concentration regions because of the resultant over-stressing of the remaining sound weld metal. However, there is no doubt that the extremely low allowable porosity levels in existing codes are unnecessarily conservative and could safely be raised to the levels suggested in Table 2(b), where the maximum allowable level is 5%. Such a level is extremely high and is never likely to occur in practice.

Three vessels were tested, each containing a continuous buried lack of penetration defect around the periphery of the nozzle weld. One of these vessels was in the low alloy steel and contained lack of penetration nominally 3 mm in depth. This vessel failed from the main seam weld after 21,000 cycles, the defective weld being uncracked.

The remaining two vessels were fabricated from the mild steel material and contained lack of penetration defects 7 and 8 mm in depth respectively. The vessel containing the 7 mm defect failed after 53,000 cycles, but the failure had initiated from the weld toe and had joined up with the planar defect. A second fatigue crack had then propagated from the planar

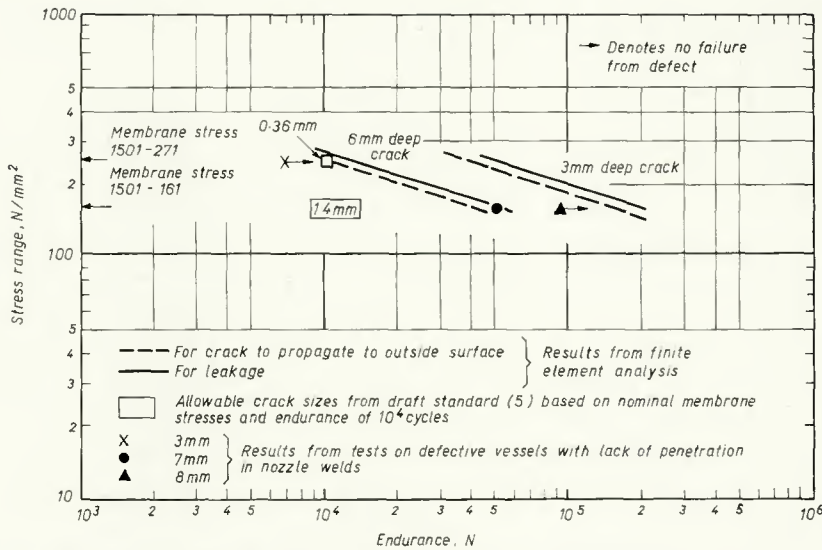

Fig. 12—Comparison of results for lack of penetration type defects

defect to form a through-thickness crack. The remaining mild steel vessel, containing an 8 mm planar defect, was taken off test at 94,000 cycles with no crack growth associated with the defect having occurred, although cracking from the weld toe had again occurred.

A theoretical crack propagation analysis was carried out for these defective nozzles making use of an existing finite element analysis program. The crack propagation law assumed in the program, based on experiments (Ref. 16) was:

$$da/dN = (1.035/10^{13}) (\Delta K)^{3.07} \quad (3)$$

when da/dN is expressed in mm/cycle and ΔK is in $Nmm^{-3/2}$.

The results obtained from this analysis, together with the actual test results, are shown in Fig. 12. It can be seen that there is good correlation between the analytical and experimental results; this indicates that fracture mechanics can be used to predict the behavior of planar defects with a reasonable degree of accuracy, even in complex geometrical regions.

Also plotted in Fig. 12 are allowable crack sizes derived from the Draft Standard (Ref. 5). Although these crack sizes were determined using the nominal membrane stress, (no account being taken of the SCF due to the nozzle geometry) it can be seen that the Draft proposals are safe for this nozzle geometry.

Fatigue in Aggressive Environments

As mentioned earlier, it was felt that a useful contribution to knowledge could be made by examining the relevance of the Draft Proposals (Ref. 5) to quantify defects operating in other than ambient temperature air environ-

ments. Tests were, therefore, made on both types of specimen shown in Figs. 4 and 9 in an elevated temperature air environment. There is a considerable amount of published literature to show that elevated temperatures can profoundly alter fatigue crack propagation behavior from that at ambient. In addition to the mild and low alloy steels used in the low cycle fatigue program, a 2¼Cr-1Mo steel to BS 1501-622 Grade 31 and an austenitic stainless steel to AISI Type 316 were also used. The steels were tested at the following temperatures:

1. BS 1501-161-350 C (662F)
2. BS 1501-271-350 C (662 F)
3. BS 1501-622-400 C (752 F)
4. AISI Type 316-450 C (842 F)

These temperatures were chosen to be outside the designated creep range of the materials to avoid complications due to crack growth by creep-assisted processes. In fact, it was found that rates of crack propagation at elevated temperature were not substantially different from those at room temperature for the mild and low alloy steels where comparison was possible.

AISI Type 316 was the only steel tested which showed an indication that the elevated temperature environment had an adverse effect upon crack growth rate. As this was the case tests on specimens containing real defects were confined to one series of specimens containing lack of penetration defects in butt welds in AISI Type 316 at 450 C (842 F). To be consistent with the low cycle fatigue program, these specimens also contained central buried defects 25 mm in length by 8 mm in depth, and were tested under both low and high cycle fatigue conditions.

The results obtained are shown in Fig. 8, plotted on the basis of total

Table 5—Value of Constant in Equations of Quality Bands

Lines between quality bands	Value of constant D, in equation describing S-N data, $(\Delta\sigma)^* N = D \cdot D$ is given in $N^4 mm^{-8}$
V-W	9.12×10^{14}
W-X	1.87×10^{14}
X-Y	3.73×10^{13}
Y-Z	7.39×10^{13}

strain range as defined in equation (2) against cycles to failure. As can be seen the results all fell within Quality Band W. As for the similar specimens tested at ambient temperature, the Draft Proposals (Ref. 5) would deem such defects acceptable to Quality Z. This work has been reported by the present author (Ref. 18), who also showed how it was possible to predict accurately the fatigue lives of such joints by taking account of the change in shape as the crack grew through the plate thickness. However, such an analysis is considered to be too complex for everyday use, and the use of the simple graphical presentation given in the Draft Proposals (Figs. 2 and 3) will yield a safe estimate of required quality.

It is worth comparing the results shown in Fig. 8. These results were obtained from similar specimens containing similar planar defects. In fact, the only differences between these test results were the specimen material and testing environment. The results indicate that both joints would be acceptable to quality W. This can be explained by fracture mechanics techniques.

Comparison of the measured rates of crack propagation in both materials and environments revealed that they were markedly similar. This leads to the important conclusion that the proposed methods of defect acceptance (Ref. 5) can be used for defects in other than ambient air environments, providing that it can be shown that the fatigue crack propagation behavior is similar to, or better than, the crack propagation behavior used to draw up the acceptance proposals. If the aggressive environment produces crack propagation rates which are more deleterious to fatigue strength than that used in the Draft proposals, the following method of deriving acceptance levels applicable to the environment in question is suggested.

Derivation of Defect Acceptance Levels for Specific Aggressive Environments

Harrison originally defined the quality bands on an S-N plot from a fracture mechanics analysis of results of tests on joints containing planar

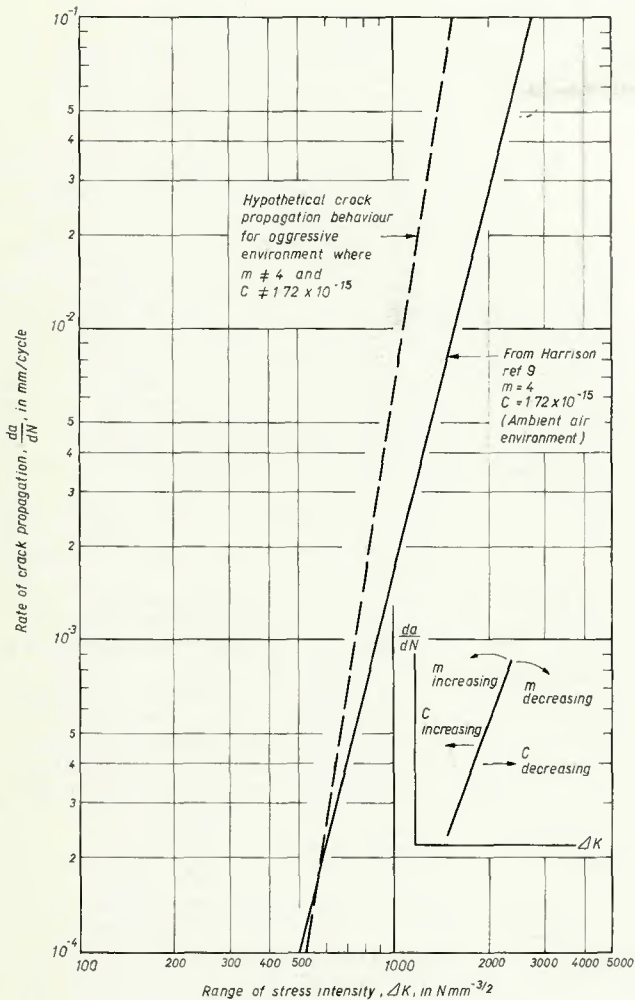

Fig. 13—Diagrammatic representation of hypothetical crack propagation behavior in ambient air and aggressive environments

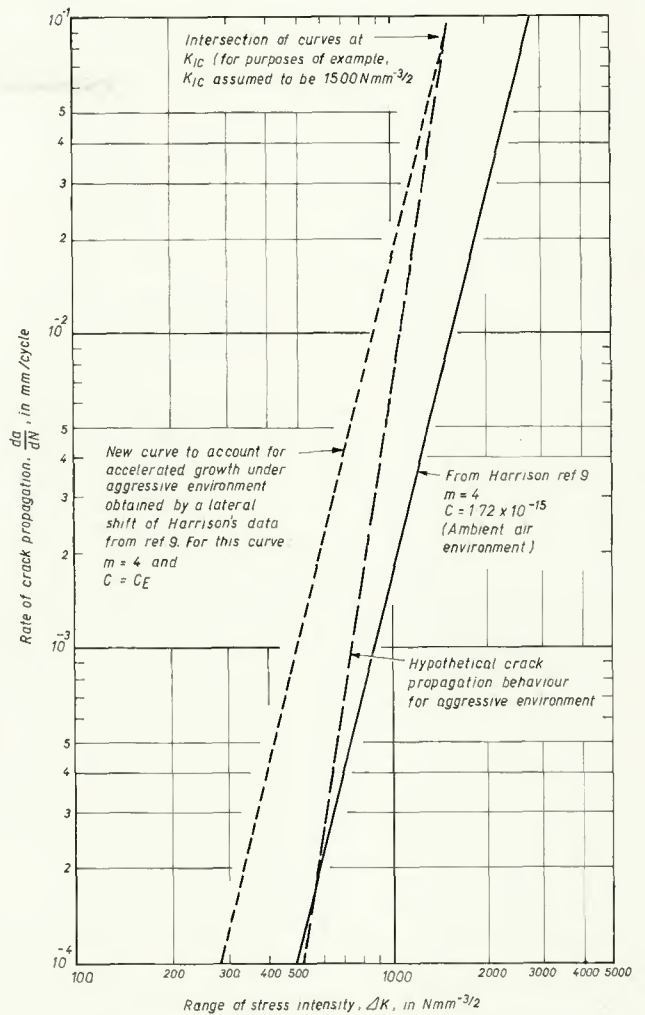

Fig. 14—Diagrammatic representation at lateral shift of ambient air crack growth curve to account for aggressive environmental effects

defects (Ref. 9). He used equation (1) to describe the rate of propagation of fatigue cracks and assumed a slope of $m = 4$. From other research (Ref. 19) it is known that the slope of the straight line, n , representing fatigue data on log-log S-N plot is related to the slope of the crack propagation curve by the relationship:

$$m = -1/n \quad (4)$$

Thus the slope of the quality bands is defined as $-1/4$. The equation of an S-N curve is given as:

$$\Delta \sigma^m N = D \quad (5)$$

where D is a constant.

By substituting for m and $\Delta \sigma$ in equation (5), the value of the constant D may be determined for the lines dividing the quality bands in Fig. 1. These values are given in Table 5.

As has been stated, environmental effects may increase crack propagation rates such that the quality band system based on ambient air test results becomes unsafe. Consider, for example, the crack propagation behavior depicted diagrammatically in Fig. 13 whereby the environment causes crack growth to occur at a higher rate

than that analyzed by Harrison. A revised system of quality levels can be derived by operating on the crack propagation law.

In equation (1) describing fatigue crack propagation, the exponent m describes the slope of the curve and the constant C the position of data relative to the axes. This is depicted on the inset to Fig. 13. While it would be possible to derive new quality bands based on a redefinition of m and C , this would lead to extremely tedious mathematics; thus a simple solution is proposed whereby the effect of slope m is ignored and a hypothetical crack propagation equation is defined which has the same slope $m = 4$ but a new constant C_E . By this means the crack propagation curve is shifted laterally across the da/dN against ΔK plot to accommodate the environment accelerated crack growth.

The position of the hypothetical data with respect to the crack propagation data obtained under the aggressive environmental conditions can be fixed by stipulating that the curves intersect at a value of ΔK equivalent to

the fracture toughness, K_{IC} , of the material in the environment. This is depicted diagrammatically in Fig. 14.

This hypothetical crack propagation equation will give an extremely conservative estimate of crack growth. However, it is felt that even grossly conservative defect acceptance standards are better than no standards at all. By always maintaining the slope $m = 4$, the quality bands can be adjusted to account for environment by simply moving them down the abscissa on the S-N plot. This is achieved by the following simple analysis.

For most welded joints undergoing fatigue, the life can be predicted by combining a solution for stress intensity at the crack tip:

$$\Delta K = Y \Delta \sigma \sqrt{\pi a} \quad (6)$$

with equation (1) describing crack growth. Combining and rearranging these equations yields an equation which may be integrated to obtain a prediction of fatigue life:

$$\int_{a_1}^{a_2} da / (Y \sqrt{\pi a})^m = C (\Delta \sigma)^m \cdot N \quad (7)$$

It should be noted that for a given set of joints or defects a_1 , a_2 and Y are constant and so the integral becomes a constant. Equation (7) may be re-written as

$$I = C(\Delta\sigma)^m \cdot N \quad (8)$$

where

$$I = \int_{a_1}^{a_2} da / (Y \sqrt{\pi a})^m$$

From equation (5), $D = (\Delta\sigma)^m N$, and equation (8) may be further re-written as:

$$I = C D \quad (9)$$

The values of D for the quality bands are given in Table 4, and the value of C was given by Harrison (Ref. 9) as $C = 1.72 \times 10^{-15}$, assuming that crack length was measured in mm and stresses in N/mm^2 .

To assess defects in aggressive environments in terms of quality, the relevant quality for the defect in ambient air environment must first be determined by the use of Table 3 and Figs. 2 and 3, depending upon defect type. Second, a crack propagation test must be carried out in the relevant aggressive environment to determine da/dN against ΔK behavior. The crack propagation data must then be adjusted to obtain an equation with a slope of 4 to obtain a conservative estimate of crack growth in the environment, as shown in Fig. 14 and the new value of the constant C_E determined.

By maintaining the slope of $m = 4$, the value of the integral I in equation (8) is constant regardless of environment. Thus, for ambient air from equation (9) and in the aggressive environment:

$$I = C_E D_E \quad (10)$$

and combining equations (9) and (10):

$$C D = C_E D_E \quad (11)$$

Values of C , D and C_E are known and so equation (11) can be solved for D_E . Values of D_E so derived may be entered in equation (5), which can be solved in terms of $\Delta\sigma$ and N to obtain revised quality bands. These quality bands will simply be downgraded in terms of allowable stress.

By nature of the fracture mechanics analysis, itself, whereby only the rate of crack propagation has been altered, the limits of acceptable defect levels (as originally defined) will still be applicable to the new quality bands.

It must be stressed that the quality band system, as originally proposed, is conservative in itself. In many cases it will adequately account for defective joints operating in other than ambient air environments. The methods of adjusting the quality bands, as described previously, should only be utilized after it has been demonstrated that the original proposals cannot

yield acceptable defect sizes, because of the increase in crack growth rate caused by the environment in question.

Conclusion

This paper has attempted to show how rationally based acceptance standards for weld defects operating under fatigue loading conditions have been derived, based on information gathered together from research carried out worldwide. Based on this information, a Draft British Standard on the derivation of acceptance levels of weld defects has now been written.

The validity of the concept of defect acceptance based on fitness for purpose has been confirmed in a recent investigation of defective joints operating in the low cycle regime and at elevated temperatures. Methods of adjusting the quality band system to account for defects operating in aggressive environments have been proposed.

One point should be made clear to those who regard the defect levels given in the acceptance proposals and in this paper as being totally unacceptable because they seem to indicate a reduction in quality. Welding costs will escalate as NDT of unsophisticated structures becomes more widespread because more and more unnecessary repairs will be made. In operating a business for profit, fitness for purpose is surely a more logical axiom than quality regardless of cost.

Author's Note

Except where direct mention is made to published research or code requirements, the views expressed in this paper are those of the author alone.

Acknowledgments

The author is grateful for the help and advice of his colleagues in the preparation of this paper—particularly to Drs. J.D. Harrison and T. R. Gurney for useful discussions.

References

1. Salter, G. R., and Gethin, J. W., "An Analysis of Defects in Pressure Vessel Main Seams," Conference on Pressure Vessel Standards—The Impact of Change, The Welding Institute, The Institution of Mechanical Engineers, The British Standards Institute, London, November 1972.
2. Lundin, S., "Some examples of the consequences of common defects in welds," Proc. 2nd Conf. on Significance of Defects, London, May 1968, The Welding Institute.
3. Dawes, M. G., "Fatigue strength of ferritic steel shafts reclaimed by welding

and metal spraying," *Brit. Weld. J.*, Vol. 10, No. 8 August, 1963, pp. 418-427.

4. Wellinger, E.H.K., and Sturm, D., "Influence of weld seam quality on the fatigue resistance under pulsating internal pressure in the case of vessels with nozzles," *IIV Document XIII-578-70*.

5. "Draft Standard Rules for the Derivation of Acceptance Levels for Defects in Fusion Welded Joints," *British Standards Institution, Draft for Public Comment, Document 75/77081 DC*, February 1976.

6. Burdekin, F. M., "Comments on the Draft British Standard for the derivation of acceptance levels for weld defects," Paper 7—Conference on Quality Control and Non-Destructive Testing in Welding, The Welding Institute, The Institute of Quality Assurance, The Non-Destructive Testing Society of Great Britain, London, November 1974.

7. Harrison, J. D., "The basis for an acceptance standard for weld defects. Part 1: Porosity," *Metal Construction*, Vol. 4, No. 3, March 1972.

8. Harrison, J. D., "The basis for an acceptance standard for weld defects. Part 2: Slag Inclusions," *Metal Construction*, Vol. 4, No. 7, July 1972.

9. Harrison, J. D., "The Analysis of fatigue test results for butt welds with lack of penetration defects using a Fracture Mechanics Approach," Paper 68, Fracture 1969, Proc. 2nd International Conference on Fracture, Brighton, April 1969, Published by Chapman and Hall.

10. Harrison, J. D., Burdekin, F. M., and Young J. G., "A Proposal Acceptance Standard for Welded Defects based upon Suitability for Service," Paper presented at 2nd Conf. on Significance of Defects in Welds, London, May 1968, The Welding Institute.

11. Soete, W., and Sys, A., "Influence of Weld Defects on High Fatigue Behaviour," Proc. 1st Int. Conf. on Pressure Vessel Technology, Delft, Sept/Oct 1969, ASME.

12. Archer, G. L., "Research on the Significance of Defects in Weld Regions of Pressure Vessels," Conf. on Pressure Vessel Standards, The Impact of Change, BSI, IMechE, and The Welding Institute, London, November 1972.

13. Harrison, J. D., "British Work on the Significance of Weld Defects," *Svetsen*, Vol. 33, No. 2, March 1974 pp 23-38.

14. "The Significance of Defects in Welded Pressure Vessels," Welding Institute Group, Sponsored Project, 1970-1975.

15. ASME Boiler and Pressure Vessel Code, Section III, Nuclear Vessels, ASME, New York, 1971.

16. Maddox, S. J., "Fatigue Crack Propagation Data obtained from parent plate, weld metal and HAZ in Structural Steels," *Welding Research International*, 4(1), 1974.

17. *British Standard 1515: Part 1 1965* "Fusion Welded Pressure Vessels, Carbon and Ferritic Alloy Steels."

18. Boulton, C. F., "Fatigue Life Predictions of Welded Specimens containing Lack of Penetration Defects at Ambient and Elevated Temperatures," The Welding Institute, Members Report E/61/75, March 1975, and published in *Pressure Vessels and Piping*, Vol. 4, No. 3, July 1976.

19. Maddox, S. J., "A Fracture Mechanics Analysis of the Fatigue Strength of Welded Joints," Ph. D. Thesis, University of London 1972.